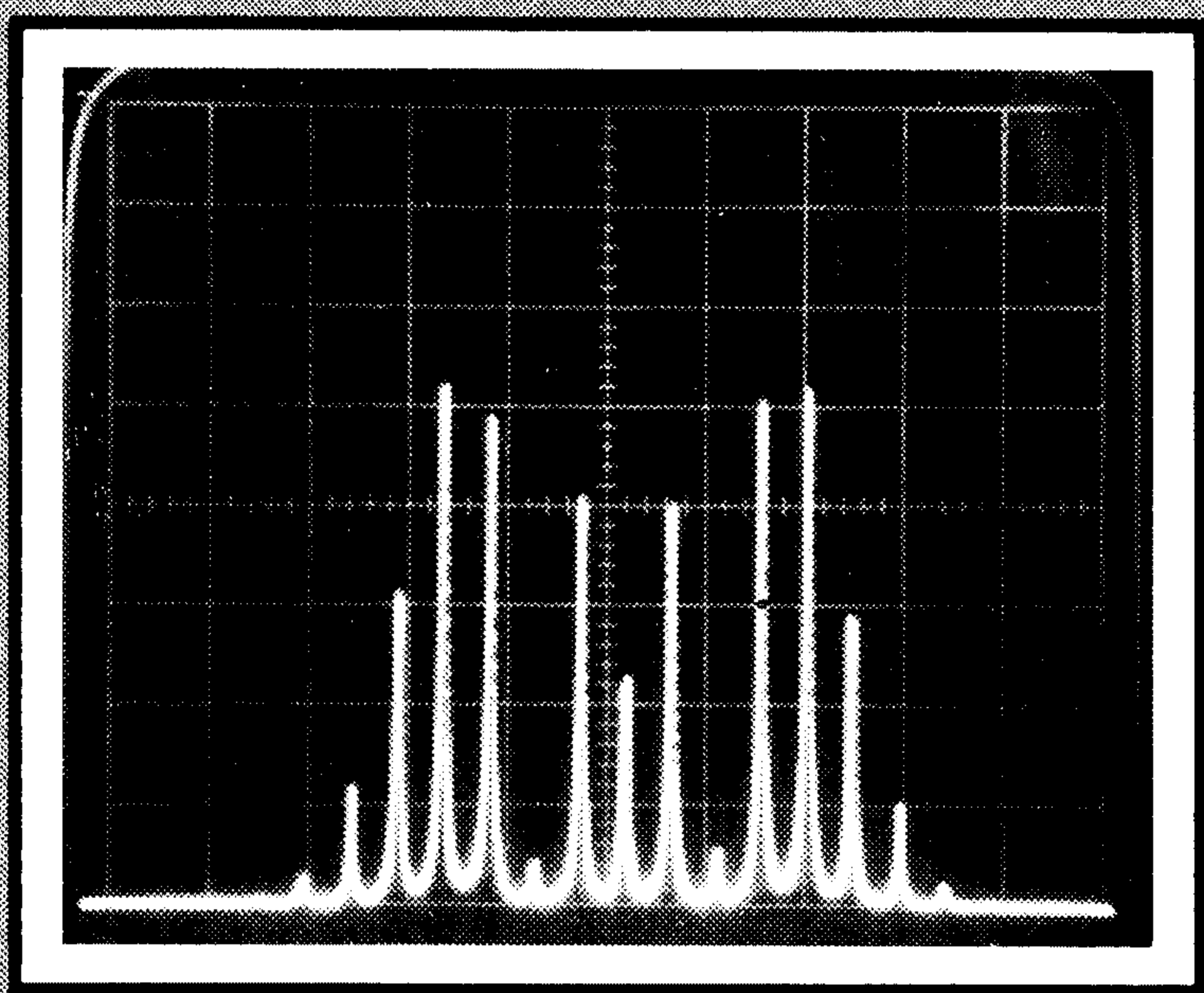
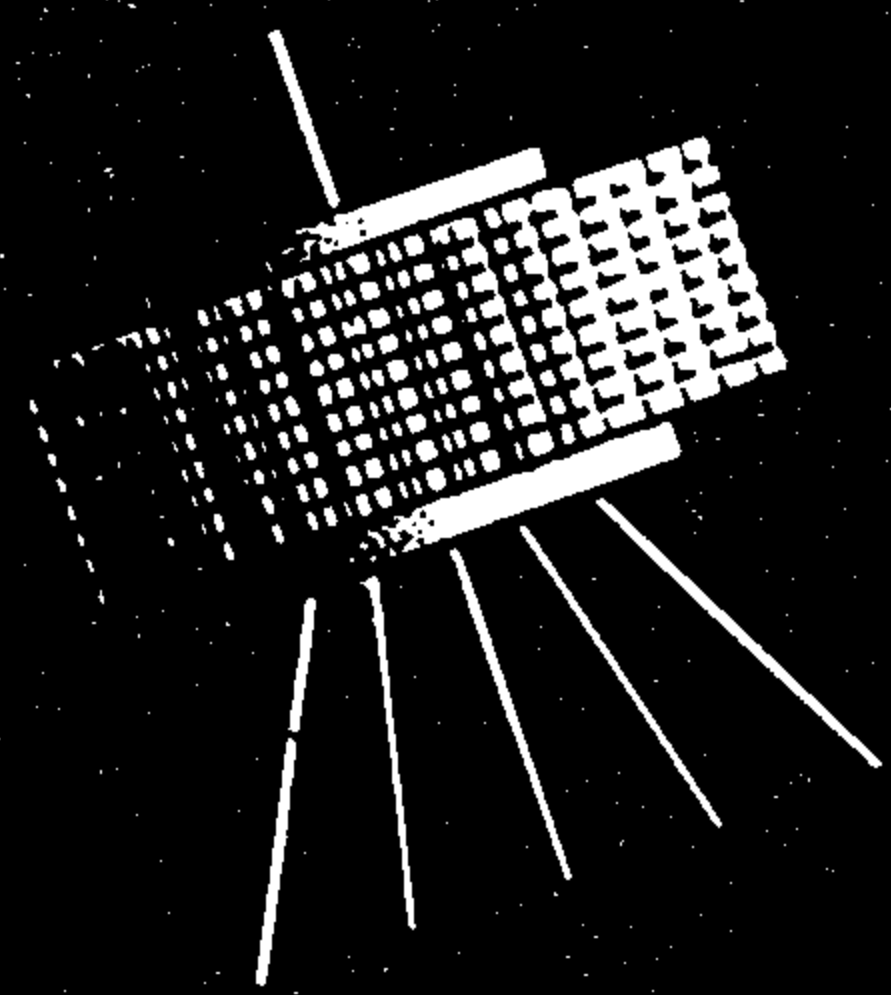
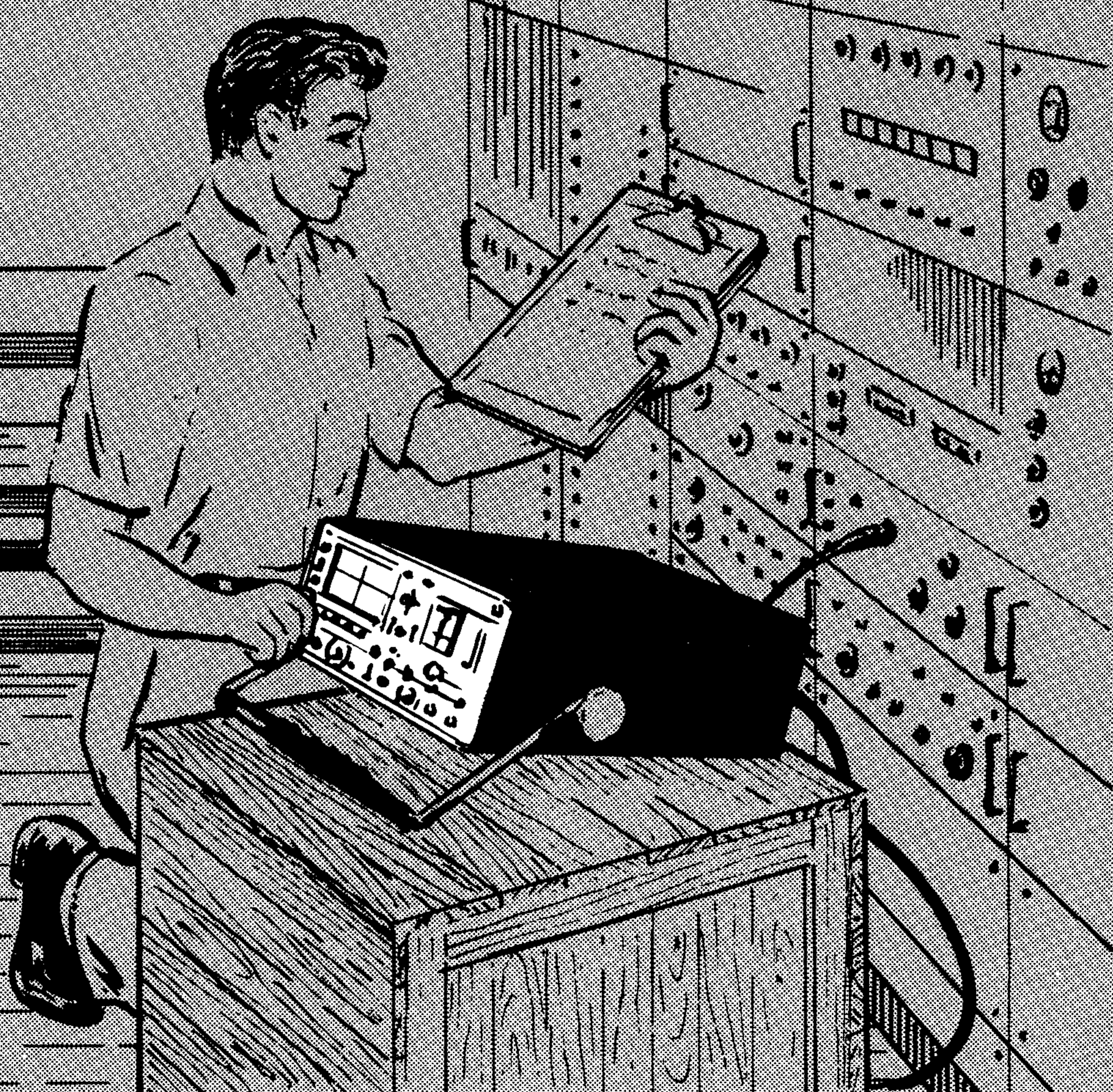




# Measurement Concepts



Spectrum Analyzer



# SPECTRUM ANALYZER MEASUREMENTS

BY  
DAN WELCH

Significant Contributions  
by  
MORRIS ENGELSON



## MEASUREMENT CONCEPTS

FIRST EDITION, SECOND PRINTING  
NOVEMBER 1969  
062-1070-00  
PRICE \$1.00

© 1969, TEKTRONIX, INC.  
BEAVERTON, OREGON 97005  
ALL RIGHTS RESERVED



## CONTENTS

	INTRODUCTION	1	
1	CONCEPT OF RF SPECTRUM TUNING	3	
2	RF MODULATION SYSTEMS	9	
3	SPECTRUM ANALYZER TERMS	23	
4	SPECTRUM ANALYZER CHARACTERISTICS AND THEIR RELATIONSHIPS		33
5	SPECTRUM ANALYZER FUNCTIONAL CONSIDERATIONS	41	
6	CW SIGNAL MEASUREMENTS	47	
7	AMPLITUDE-MODULATION MEASUREMENTS		65
8	FREQUENCY MODULATION MEASUREMENTS		71
9	SINGLE-SIDEBAND MEASUREMENTS		81
10	PULSED RF CARRIER MEASUREMENTS		87
11	SWEPT FREQUENCY MEASUREMENTS		97
12	FLUID VELOCITY MEASUREMENTS		99
13	WAVEFORM ANALYSIS	101	
	INDEX	103	

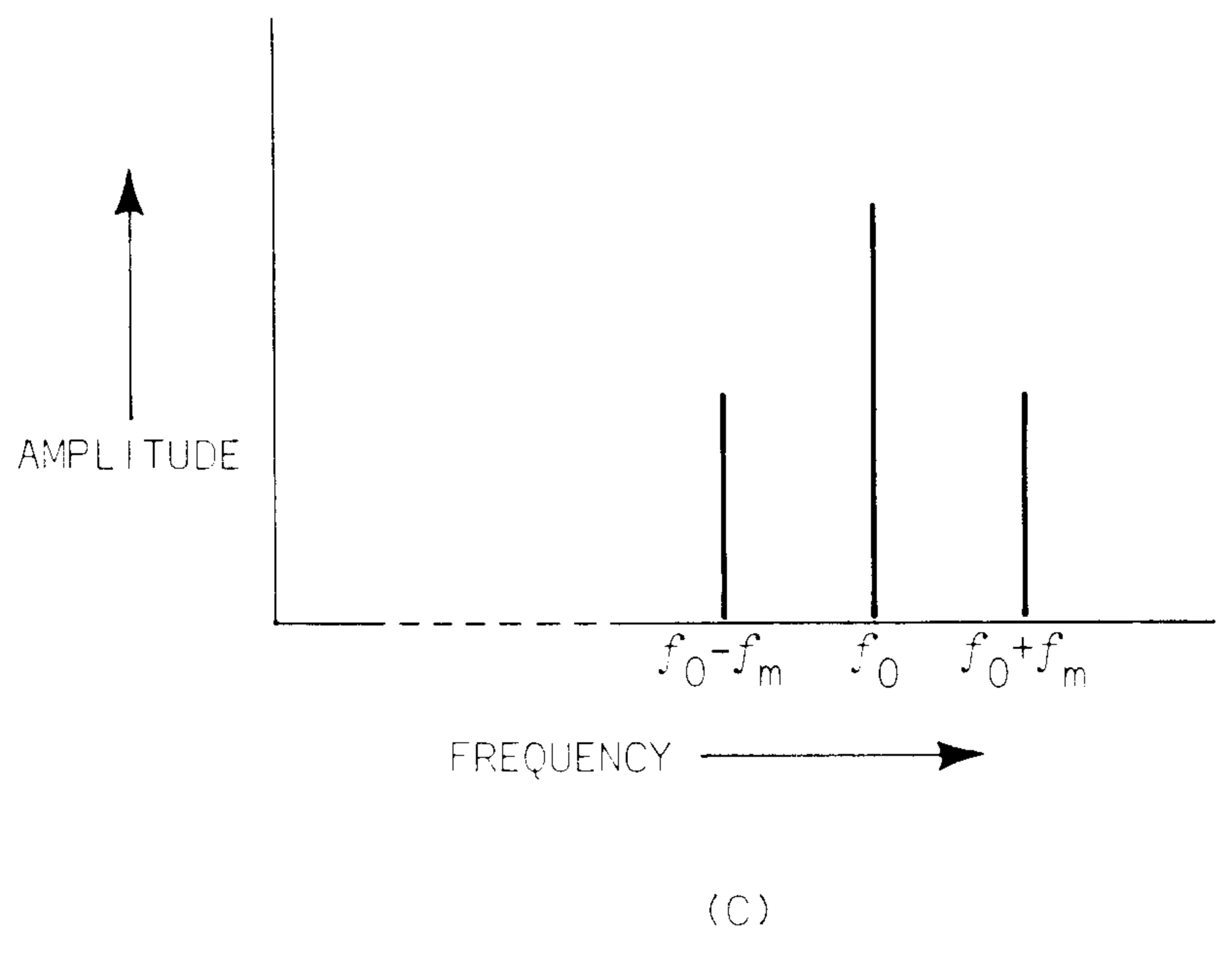
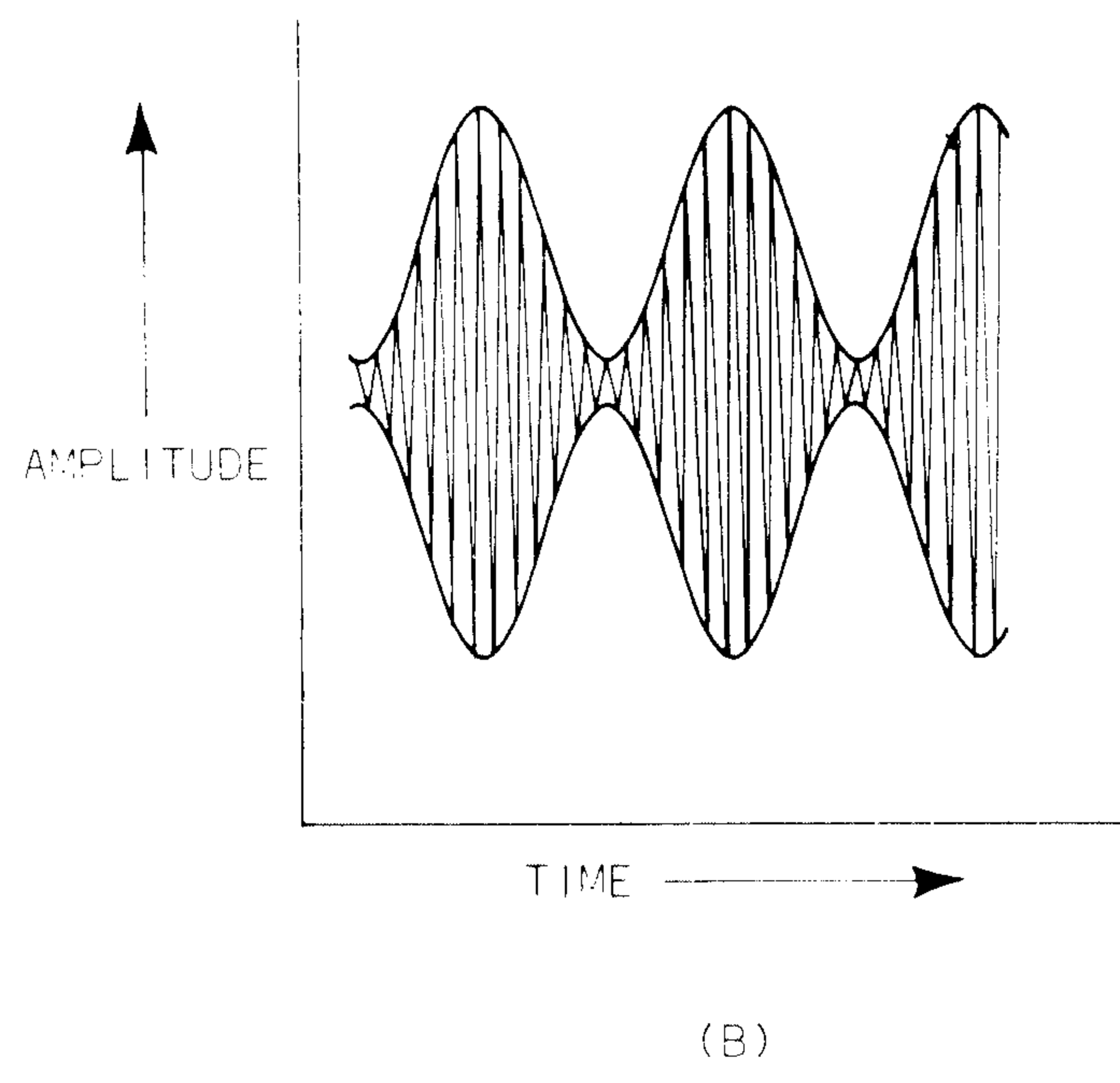
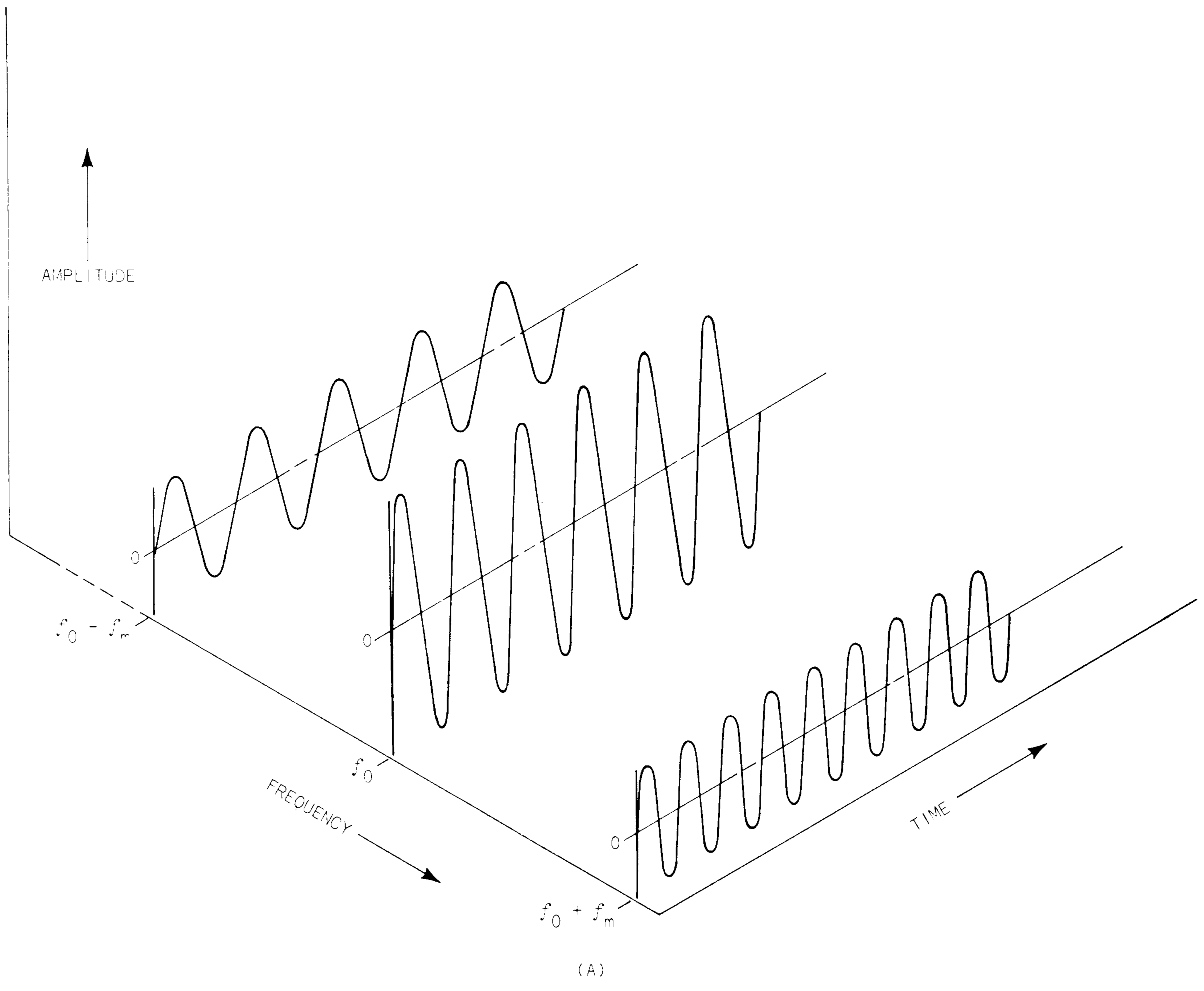
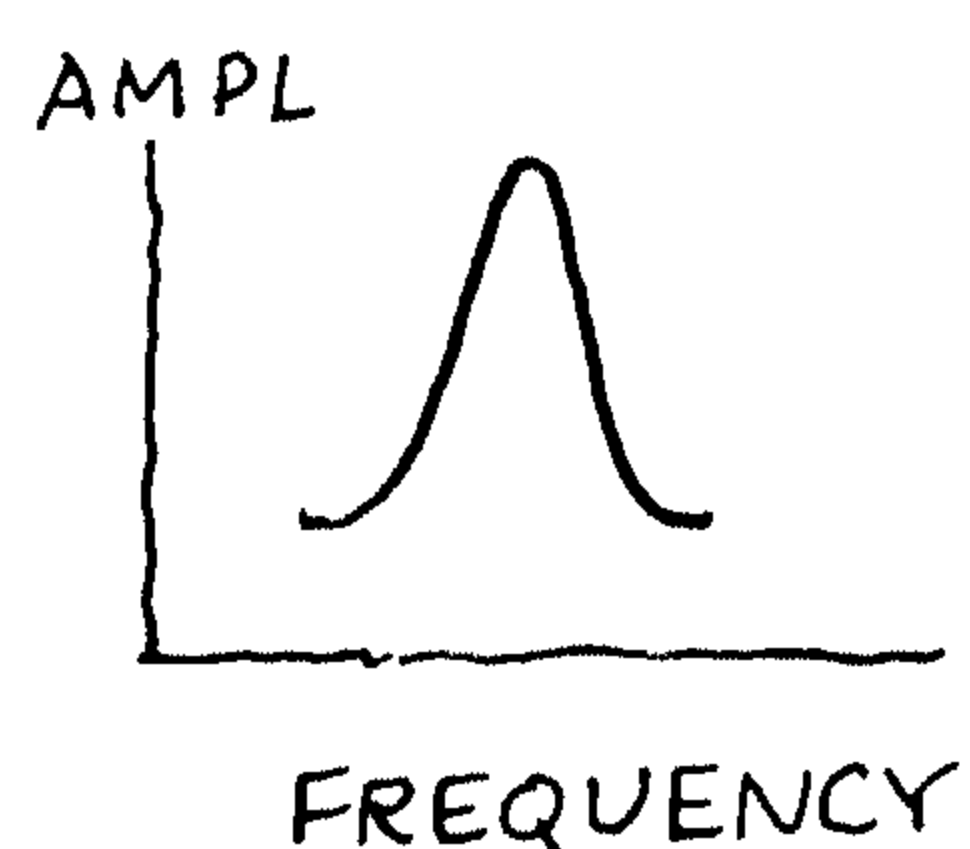
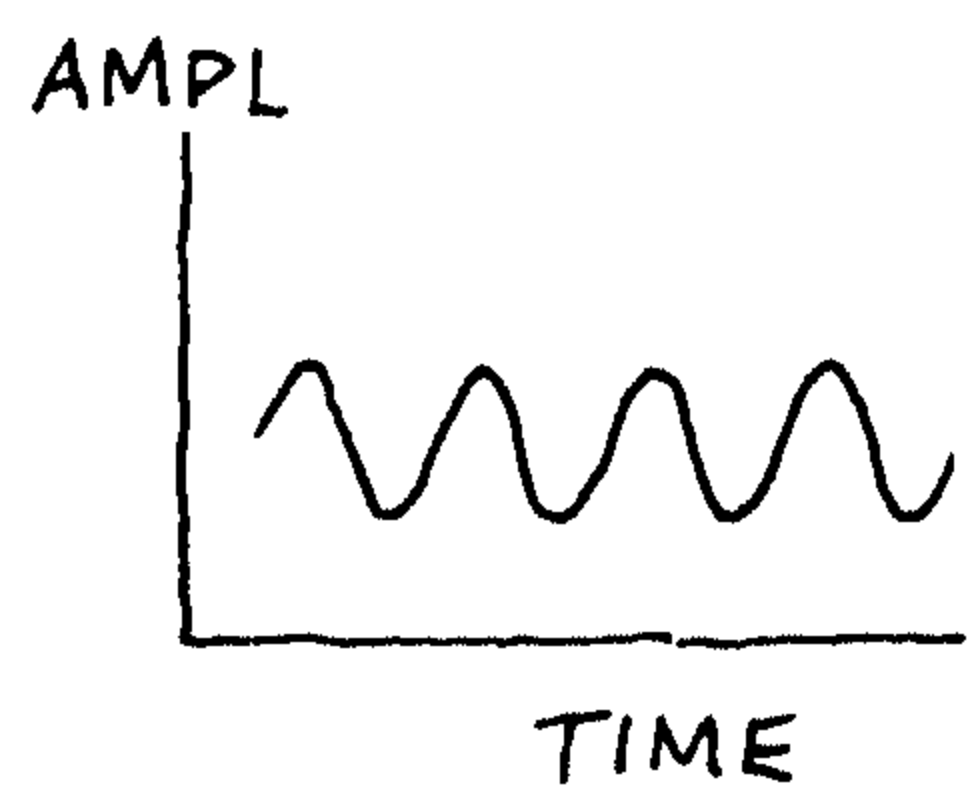


Fig. I-1. Amplitude, time and frequency.

## INTRODUCTION

In the field of electronic measurements, electrical signals may be analyzed in either the time or frequency domain. Electrical signals are functions of both time and frequency. (Fig. I-1A).

In the time domain the amplitude of a signal with respect to a time axis may be displayed on the screen of a cathode-ray-tube oscilloscope. Information regarding signal amplitude, duration, periodicity, risetimes and falldurations may be derived directly from the calibrated display. These characteristics are time functions of the signal. If the applied time-function signal only contains one frequency, information about that frequency can be obtained from the display. However, if the signal contains more than one frequency, each of which might have a different amplitude, they will be combined into a single waveform and the individual characteristics of each will then become difficult if not impossible to measure from the display. Fig. I-1B illustrates a two-dimensional time domain display of the frequencies shown in Fig. I-1A. In the frequency domain a vertical response is displayed on a cathode-ray tube for every frequency component present in the applied signal (Fig. I-1C). The horizontal position of each response is a function of its frequency while the height of the response is related to its amplitude.



Just as an oscilloscope displays signal amplitude vertically across the horizontal *time* axis of a cathode-ray tube, an electronic instrument called a spectrum analyzer displays signal amplitude vertically across the horizontal *frequency* axis of a cathode-ray tube. Such an instrument is essentially a combination of a sensitive receiver and the horizontal sweep section of a cathode-ray tube oscilloscope.

Spectrum analyzers may be used to perform a wide variety of radio-frequency (RF) measurements directed toward the analysis and measurement of discrete, random, impulse and composite type of signals. Evaluation of the relative amplitudes and frequencies of the discrete components of RF signals provides information on bandwidths, modulation characteristics, spurious signal generation and other information either impossible or impractical to obtain by any other means. Typical measurements performed with microwave, RF and low frequency signals are described to indicate the variety and types of measurements which may be more effectively performed with spectrum analyzers.

## 1

CONCEPT OF  
RF SPECTRUM TUNINGfrequency  
sampling

Unlike an oscilloscope which may be capable of displaying the waveform of a single transient, a spectrum analyzer usually requires a repetitive signal in order to provide a satisfactory display. This is so because at any one instant, the receiver portion of a sweeping spectrum analyzer can only be tuned to a single component of a frequency spectrum. If a frequency present in a single transient is not in coincidence with the frequency to which the spectrum analyzer is tuned at the time of occurrence, it will not be displayed.

If, however, a given frequency is present in a repetitive signal and the spectrum analyzer is made to tune across the portion of the frequency spectrum in which the frequency exists, the spectrum analyzer will display the amplitude of the frequency on the face of the cathode-ray tube.

Whenever the analyzer is made to tune periodically across a range of frequencies in which a signal frequency is repetitively present, the analyzer will display the signal each time the spectrum analyzer is tuned to the signal frequency. The signal will occupy the same position on the face of the cathode-ray tube with each succeeding horizontal sweep of the trace.

If the tuning range is altered to a slightly different portion of the spectrum, the signal may still be displayed, but will occupy a different position horizontally on the face of the cathode-ray tube than it did previously.

coincident

When additional signals are repetitively present, the analyzer will also display *their* frequency components. The display will show the amplitude of each frequency component relative to the others. For a signal to be displayed it must exist at frequency  $f$  at the same time the spectrum analyzer is tuned to frequency  $f$ .



Tuning of the spectrum analyzer through an RF spectrum is usually accomplished electronically. It is commonly referred to as *sweep tuning*, *frequency sweeping*, or *scanning*.

If the sweep tuning is performed in the input mixer stage of the analyzer, the analyzer is called a *swept front-end* type. If the RF spectrum is first heterodyned or converted to an intermediate-frequency spectrum prior to being sweep tuned, the spectrum analyzer is called a *swept IF* type. The functional operation of a spectrum analyzer is to scan a portion of the radio frequency in synchronism with a horizontal deflection voltage and to display, usually on a CRT, any signals present in the spectrum in terms of their component frequencies and relative amplitudes.

swept  
front-end

Fig. 1-1 illustrates a simplified functional block diagram of a swept front-end spectrum analyzer. Signal frequencies are applied to the wideband input circuit of the mixer stage where they are mixed with the swept oscillator frequency. The resultant mixer output contains a multitude of frequency products, most of which are filtered away in the following narrow-bandwidth IF filter. Of major interest are the first-order sum and difference-frequency products, when sum or difference frequencies are compatible with the bandpass of the following narrow intermediate-frequency amplifier stage. The change in local oscillator frequency from the beginning to the end of its sweep determines the scan width.

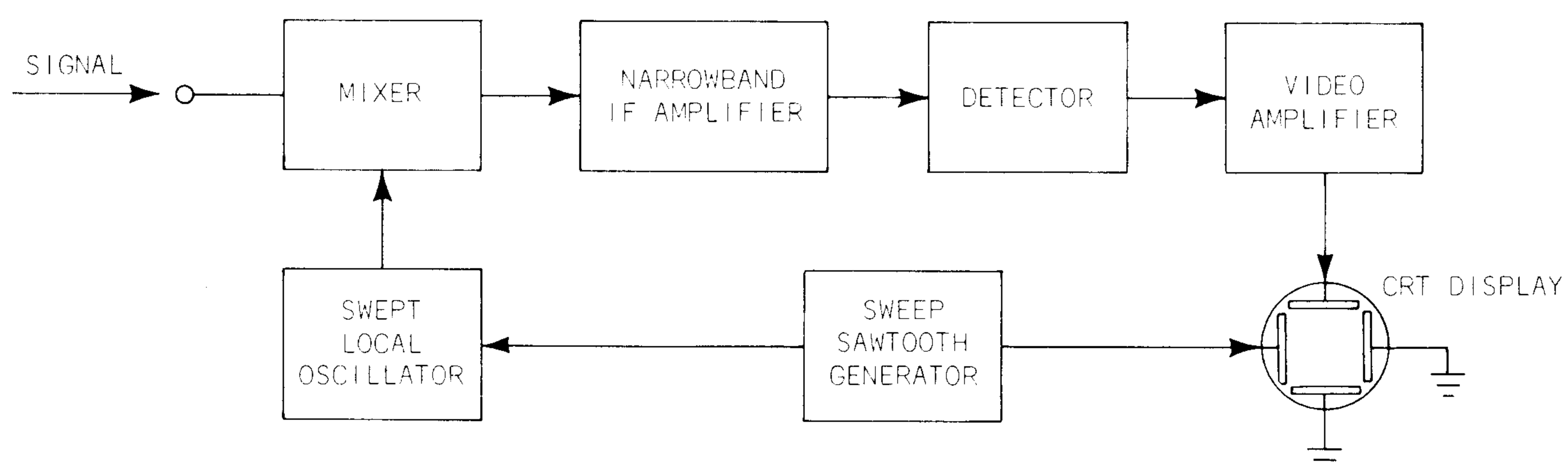


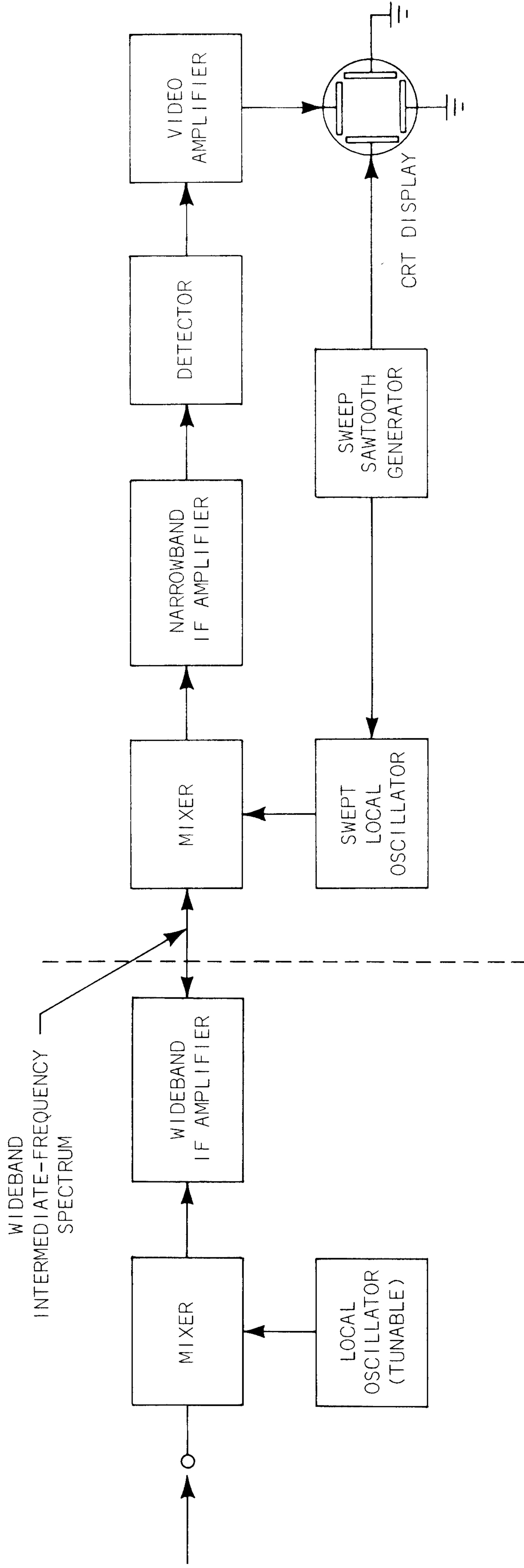
Fig. 1-1. Simplified block diagram of swept front-end type of spectrum analyzer.

The intermediate-frequency amplifier provides the required amplification and signal resolution bandwidth necessary for a satisfactory display.

The detector rectifies the signal output of the IF. The detector output consists of the envelope of the output signal. Linear, square law or logarithmic displays of the input signal are generally available.

The video amplifier provides amplification of the detector output signal for vertical deflection of the displayed signal.

A horizontal sweep sawtooth generator provides CRT deflection voltage as well as sweep voltage to tune the swept local oscillator across the selected dispersion.



CONVERSION OF RF SPECTRUM TO AN INTERMEDIATE-FREQUENCY SPECTRUM

Fig. 1-2. Simplified block diagram of swept IF type of spectrum analyzer.

swept IF

Fig. 1-2 illustrates a simplified block diagram of a swept IF type of analyzer. The portion ahead of the dotted line indicates the additional frequency conversion stage required to convert the RF spectrum to that compatible with the swept local oscillator.

modern  
spectrum  
analyzer

In recent years the use of the varactor diode in conjunction with transistorized frequency-control feedback circuitry has led to the development of spectrum analyzers providing calibrated dispersions and occupying a fraction of their former size and weight. The use of solid-state devices to perform the functions previously performed by vacuum tubes has resulted in decreased power requirements and economy in design. As a result, the spectrum analyzer is becoming as standard a laboratory test instrument as the wideband oscilloscope.

Portability in a general-purpose spectrum analyzer is now a reality, in the solid state, Tektronix Type 491, shown in Fig. 1-3.

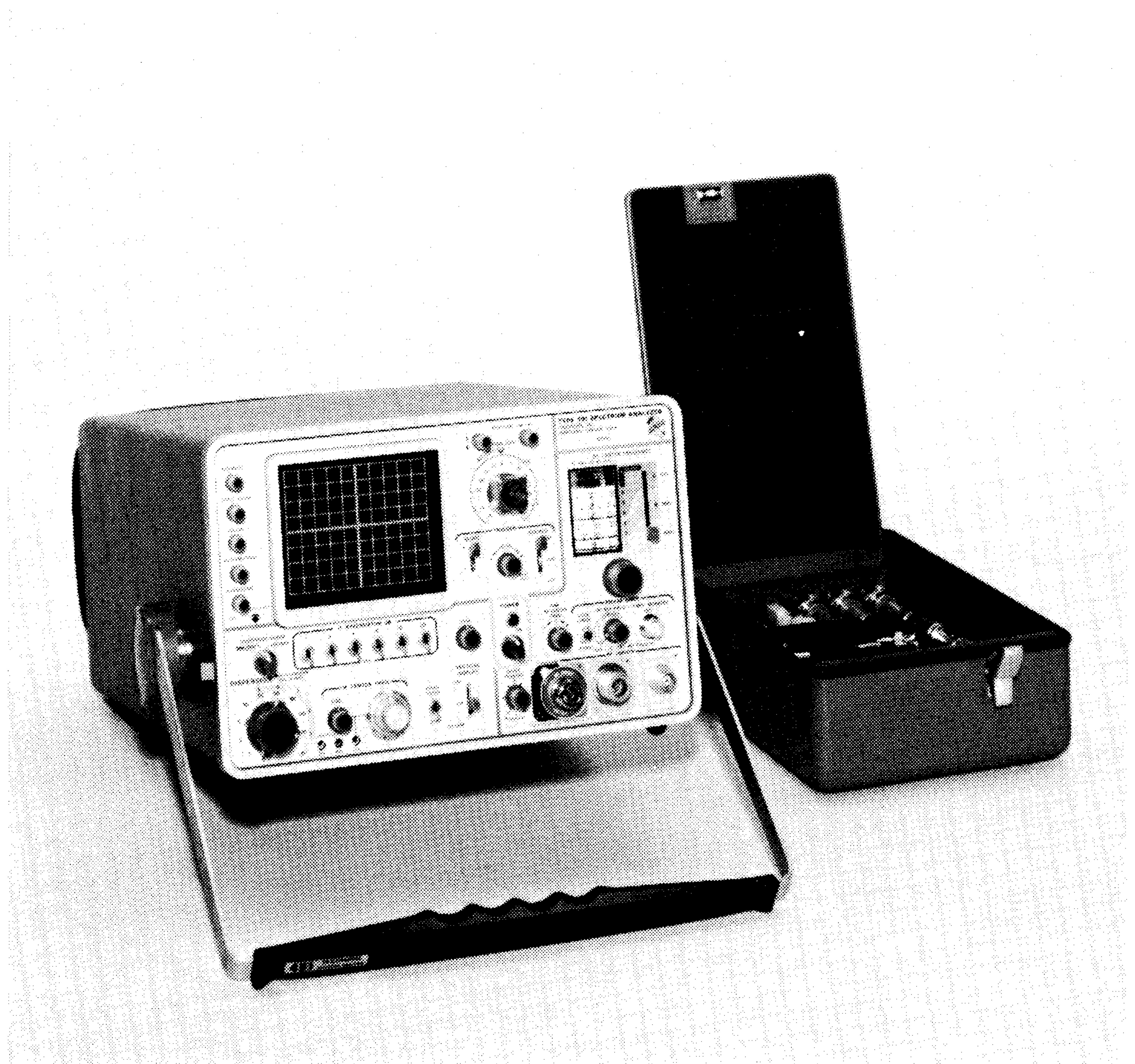


Fig. 1-3. Tektronix Type 491.





## 2

## RF MODULATION SYSTEMS

A constant radio-frequency (RF) continuous wave does not convey any information other than its presence in the electromagnetic spectrum. To carry information requires that some characteristics of the RF wave be changed in accordance with the information to be transmitted. Characteristics of the radio-frequency wave which may be varied in order to impart information are amplitude, frequency and phase, or complex combinations of these. The electronic process by which an RF wave characteristic is varied in accordance with the information to be transmitted is called modulation. Since information must modulate the RF wave in order to convey intelligence, the RF wave merely acts as a *carrier* and is commonly referred to as the *RF carrier*. When intelligence is impressed on the RF carrier it is often called a modulated carrier; the implied understanding being that information composed of lower frequencies has been imparted to the RF carrier. An RF wave is a similar concept to a modulated carrier in that it consists of all the modulation signal components present at the radio frequency.

RF carrier

modulation

Modulation of the RF carrier may be classified under one or more of four descriptive classifications:

1. Amplitude modulation
2. Frequency modulation
3. Phase modulation
4. Pulse modulation (really a specialized form of amplitude modulation).

There are four forms of amplitude-modulation systems in general use in RF communications.

amplitude  
modulation

- A. Double sideband with carrier (standard AM)
- B. Double sideband suppressed carrier (DSSC)
- C. Single sideband suppressed carrier (SSSC or SSB)
- D. Pulse-modulated carrier or pulsed RF carrier.

double  
sideband  
with carrier

In amplitude-modulated systems the amplitude of the RF carrier is made to vary in accordance with the modulation frequency. A modulation frequency may be a simple audio tone or an aggregate of frequencies forming a complex signal.

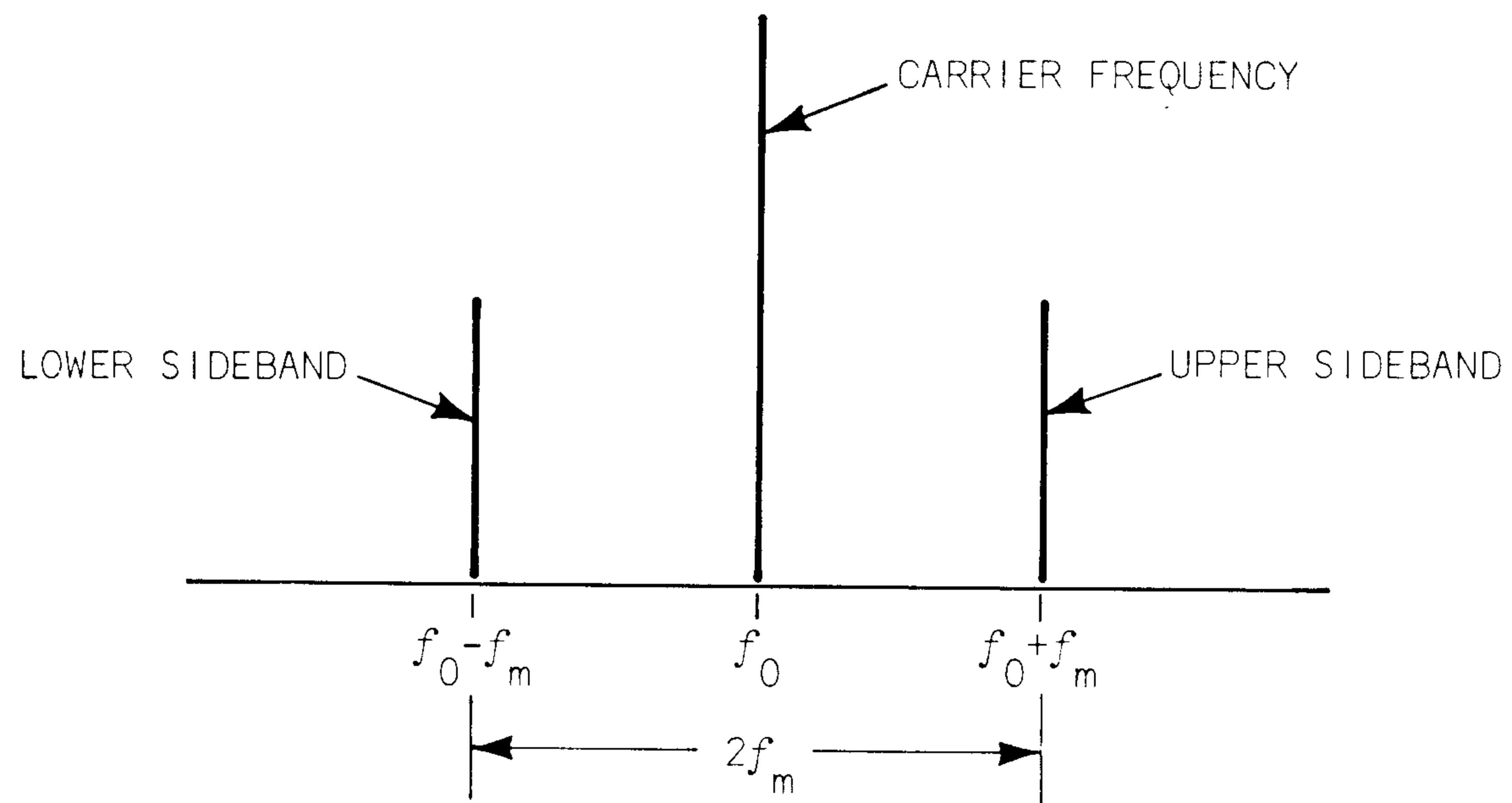
In order to simplify the understanding of the modulation concept in this publication, modulation frequency will be considered as a single frequency in the audio range.

sidebands

When an RF carrier is amplitude modulated with a single audio frequency, two new radio frequencies called sidebands are generated. The sideband frequencies are termed the upper sideband and the lower sideband. The frequency of the upper sideband is equal to the RF carrier plus the modulating frequency and the frequency of the lower sideband is equal to the RF carrier minus the modulating frequency.

fully  
modulated  
(100%)

The width of the RF spectrum (Fig. 2-1) occupied by an amplitude-modulated RF wave is equal to twice the highest modulating frequency,  $f_m$ , and is centered about the carrier frequency,  $f_0$ . In the standard AM system the amplitude of the RF carrier is maintained constant while the amplitude of the sidebands vary in accordance with the amplitude of the modulating frequency. The amplitude of the sideband frequencies in relation to that of the RF carrier indicate the degree of modulation applied to the carrier. The carrier is said to be fully modulated (100%) when the sum of the power in the upper and lower sidebands is equal to one-half of the power in the RF carrier. This occurs when the amplitude of each sideband is equal to one-half the amplitude of the carrier. The equivalent display in the time domain is shown in Fig. 2-2.



STANDARD AM REQUIRES AN RF SPECTRUM EQUAL TO TWICE THE INFORMATION BANDWIDTH

Fig. 2-1. Amplitude-modulated RF carrier spectrum.

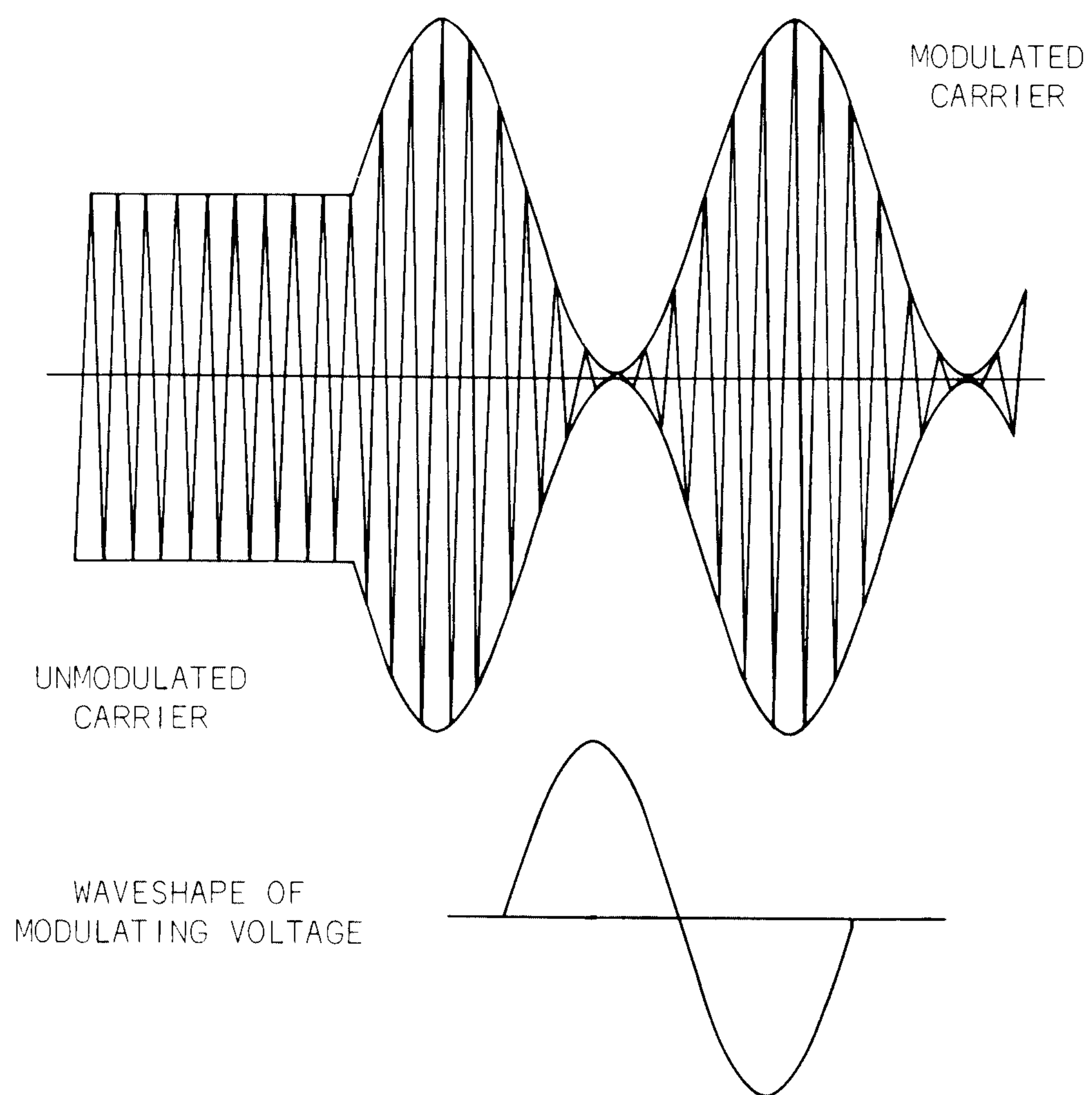


Fig. 2-2. Time domain display of 100% modulated RF carrier.

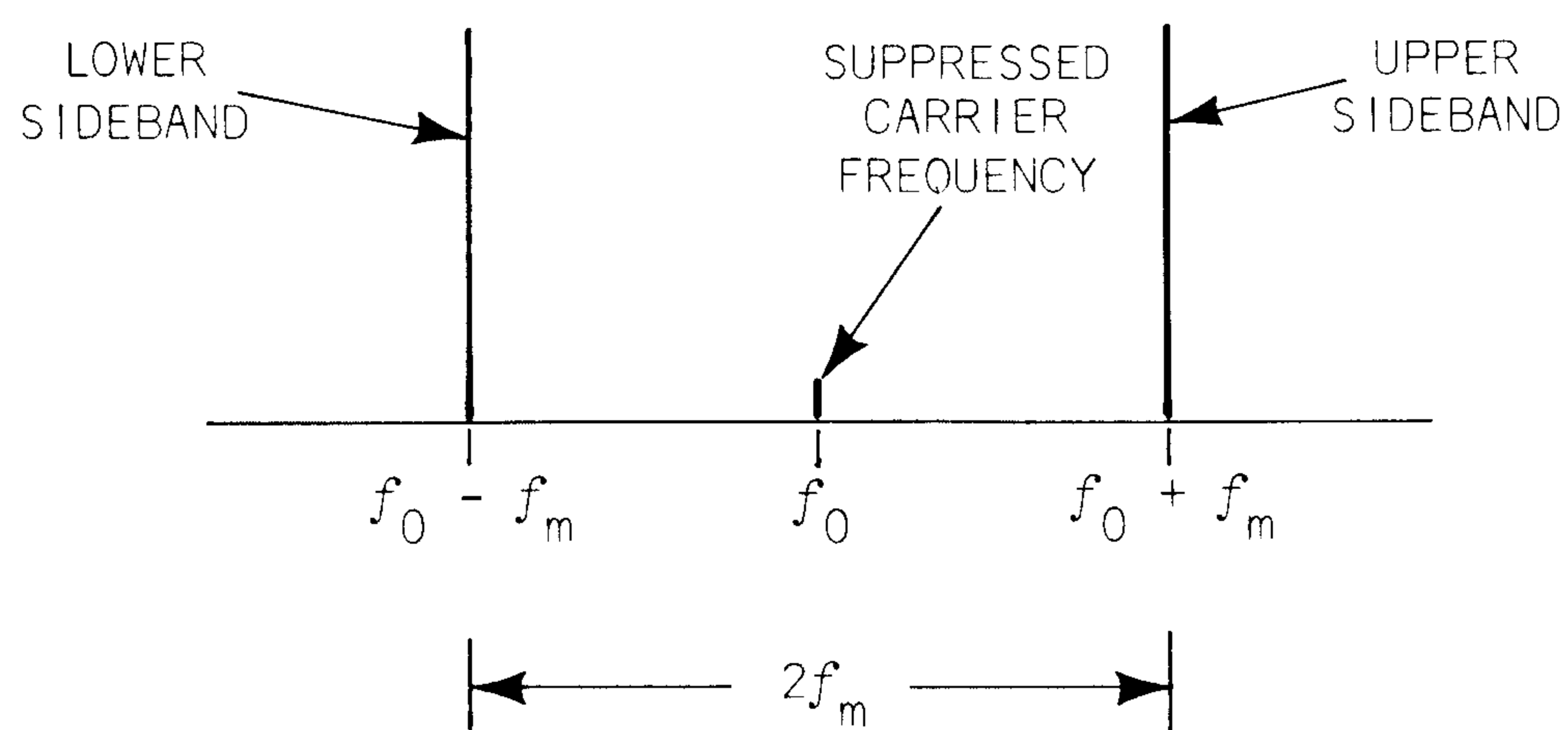
amplitude  
modulation

RF carrier

Amplitude modulation furnishes both the intelligence-carrying sidebands and the necessary reference carrier against which these sidebands may be demodulated at the receiver. AM is used for communications and commercial broadcasting. Its primary advantage is that it transmits a reference carrier to which the sidebands may be related and demodulated. The magnitude of the RF carrier also serves to develop automatic gain control voltages to ensure constant output amplitude and frequency stability for the receiver. AM does not require the use of complex receiver circuitry to be received. A simple RF-envelope diode detector followed by audio-frequency amplification is sufficient in some instances.

double  
sideband  
suppressed  
carrier  
(DSBSC)

In the standard amplitude-modulation system described, the presence of the carrier serves merely to simplify the receiver design. With appropriate receiver design the need for the RF carrier may be eliminated, permitting the use of a double-sideband suppressed carrier modulation system (Fig. 2-3).



SUPPRESSED CARRIER DOUBLE-SIDEBAND REQUIRES AN RF SPECTRUM EQUAL TO TWICE THE INFORMATION BANDWIDTH.

Fig. 2-3. Amplitude-modulated double-sideband suppressed carrier (DSBSC).

When the RF carrier is fully amplitude modulated (100%) two-thirds of the transmitted power is in the RF carrier and only one-third in the useful sidebands. For modulation percentages less than 100% (usually the case), the ratio of power in the RF carrier to that in the sidebands is substantially higher. As a result, a great deal of transmitter power is wasted in the formation of the RF carrier. Furthermore, it is the interaction of adjacent carriers and sidebands which generate audible whistles and squeals that hamper communications under crowded spectrum conditions.

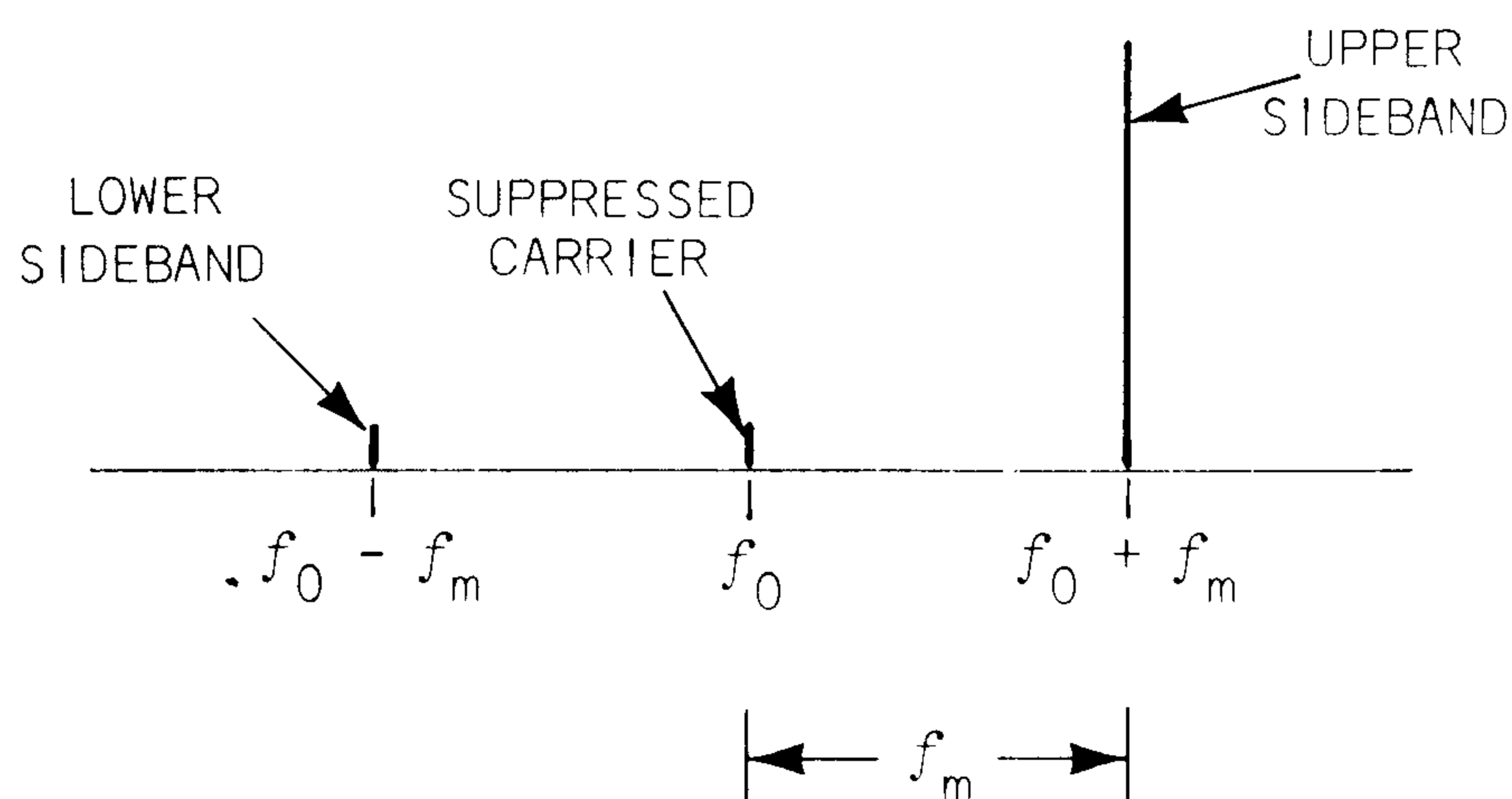
Suppression of the RF carrier by means of balanced modulator techniques results in several advantages:

1. Decreases sources of possible interference.
2. Transmitter design is simplified, resulting in cost economy.
3. All available power may now be applied to the information-carrying sidebands.

Greater circuit complexity on the part of the receiver is demanded because a stable substitute for the RF carrier must be generated within the receiver itself.

single  
sideband  
suppressed  
carrier

Single-sideband modulation techniques (Fig. 2-4) were initially developed in the early days of radio and utilized by telephone companies in the development of carrier multiplex systems at low frequencies. With the development of improved electronic components and circuitry following World War II, single sideband became a practical mode for speech transmission throughout the RF spectrum, extending well into the microwave region.



SINGLE SIDEBAND SUPPRESSED CARRIER REQUIRES AN RF SPECTRUM EQUAL TO THE INFORMATION BANDWIDTH

Fig. 2-4. Amplitude-modulated single-sideband suppressed carrier (SSBSC).

power  
efficiency

In addition to suppressing the carrier for reasons already cited it is also possible to reduce the bandwidth of the transmitted signal by eliminating one of the sidebands. The transmitted signal will then occupy a bandwidth which is one-half of the RF spectrum required by standard AM and double-sideband suppressed-carrier modulation systems. Receivers with narrower bandwidths can be used, improving system signal-to-noise ratios over that possible with double-sideband modulation methods. With the carrier



and one sideband suppressed, all the available transmitter power can be applied to the signal-carrying sideband. System power efficiency improvement over double-sideband AM system results because there is no power output from a single-sideband transmitter in the absence of modulation.

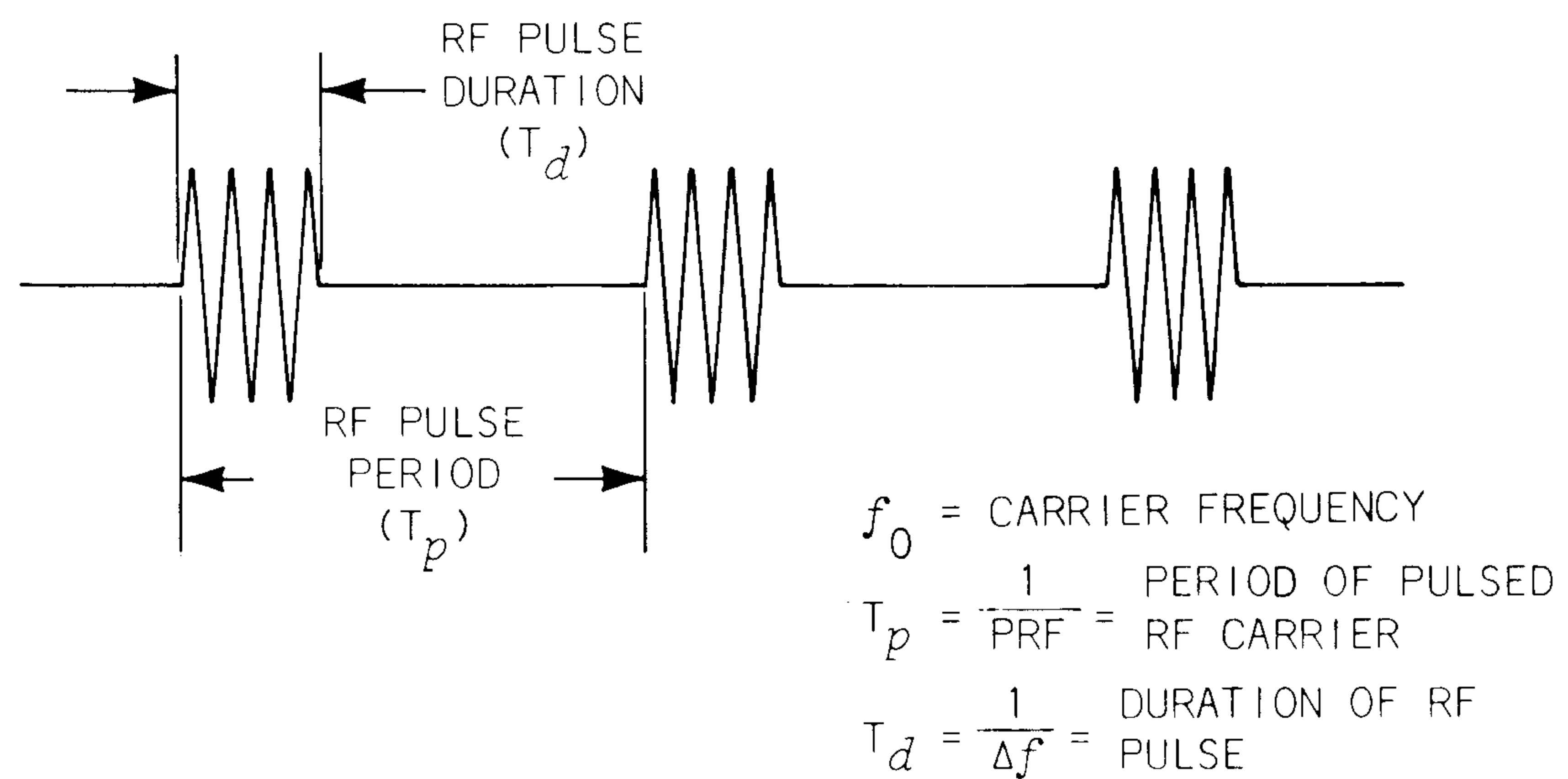


Fig. 2-5. Pulsed RF carrier in the time domain.

pulse-  
modulated CW  
pulsed RF  
carrier

Pulse-modulated CW or pulsed RF carrier (Fig. 2-5) is generally considered a form of amplitude modulation. The frequency, amplitude, duration and the period of the RF pulses remain constant. The RF spectrum for this kind of signal is described mathematically by the Fourier transform of the input function and is the type generally referred to as a  $\frac{\sin x}{x}$  type of display. It is the type of RF spectrum usually generated by a properly operating pulsed radar.

The spectrum envelope of a pulsed carrier can be derived by the Fourier transform equation. Any discrepancies from the ideal spectrum indicates an undesirable operating condition occurring in the device used to generate the pulsed RF carrier and therefore performance can be evaluated in terms of an available ideal standard.

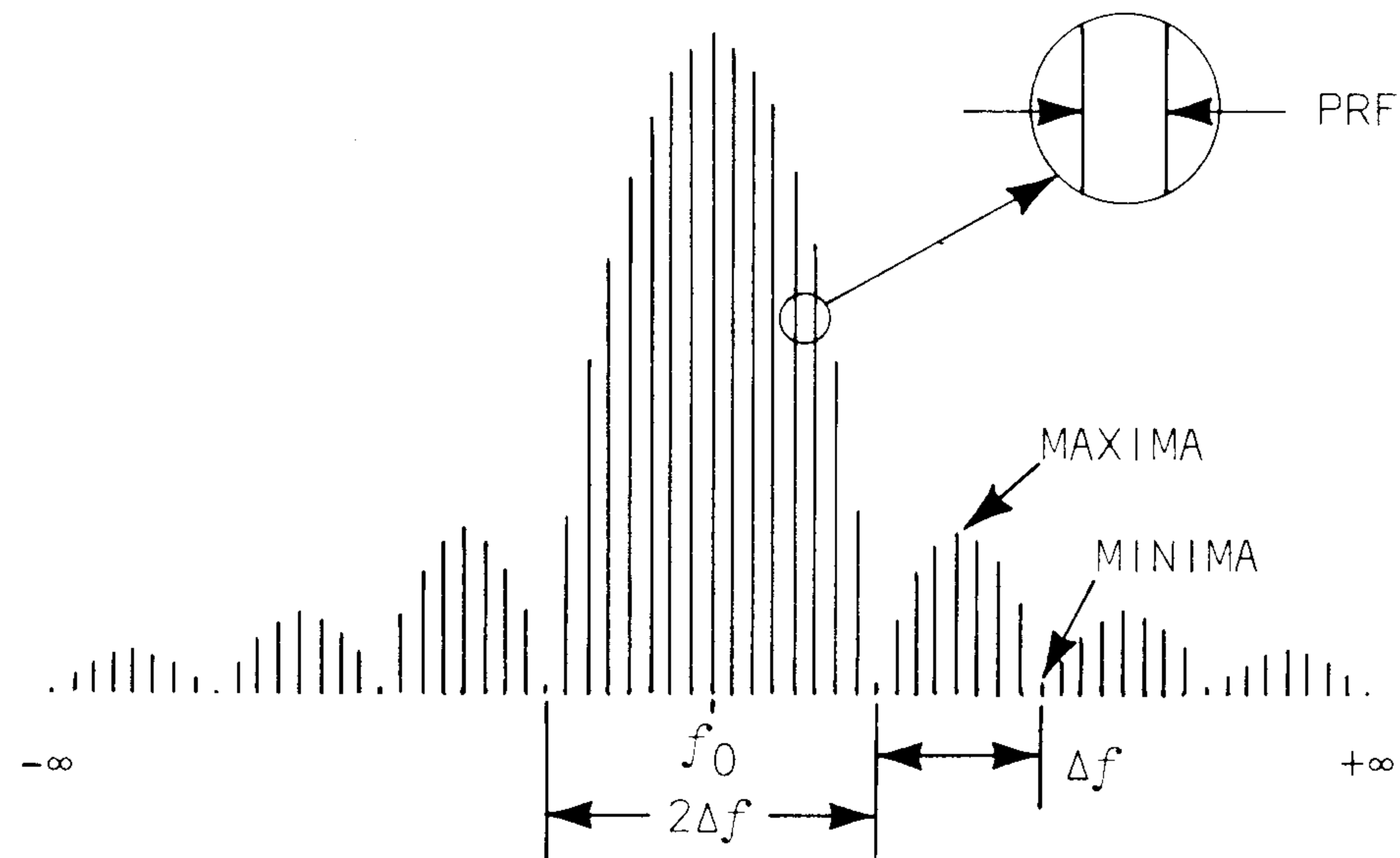


Fig. 2-6. Illustration of a pulsed RF spectrum ( $\frac{\sin x}{x}$  type) in the frequency domain.

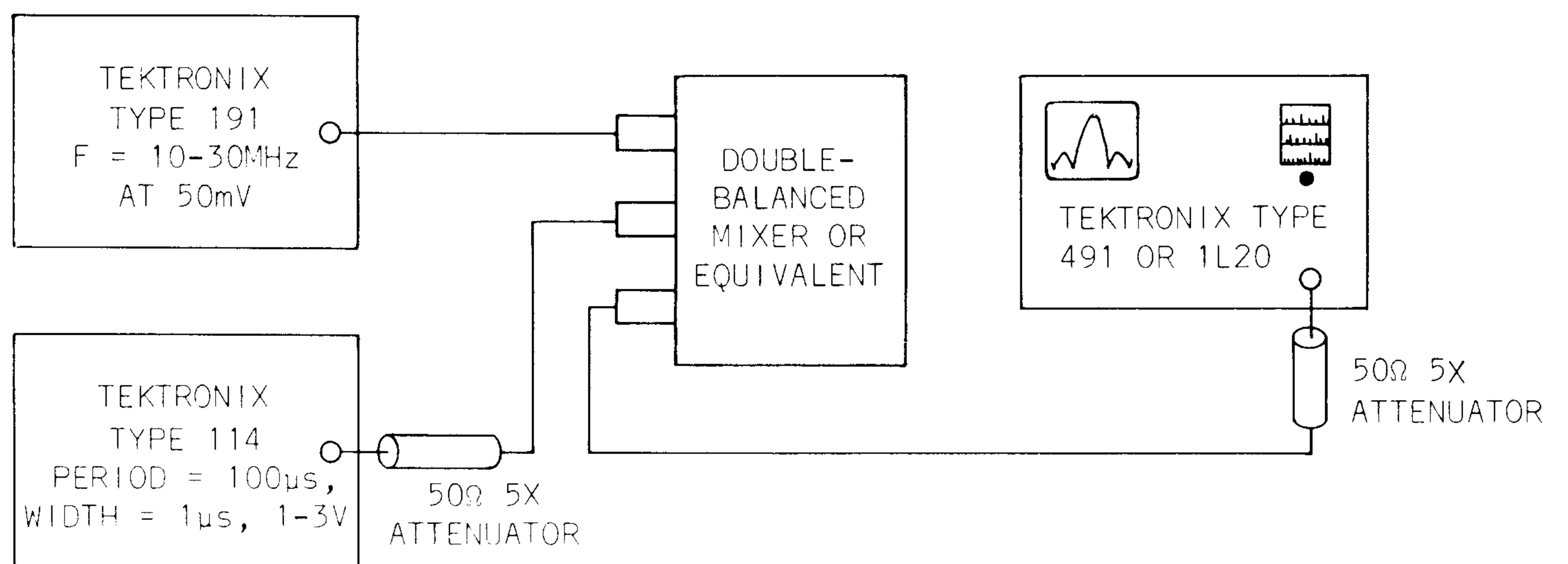
Fig. 2-6 represents the RF spectrum of a perfectly rectangular RF pulse, free of any amplitude or frequency modulation, as would be displayed on a spectrum analyzer operated in the linear vertical-display mode. The form of the RF spectrum consists of a central major lobe centered about the RF carrier frequency and minor lobes extending on either side with diminishing amplitude. The RF spectrum extends in both directions from the carrier frequency and the width of the major lobe is equal to twice the width of the minor lobes. The frequency spacing between consecutive minor lobe minima is related to the duration of the RF carrier pulse by the expression  $\Delta f = \frac{1}{T_d}$  where  $\Delta f$  is equal to the frequency difference in hertz between consecutive lobe minima and  $T_d$  is equal to the RF pulse duration in seconds.

frequency  
spacing

Since the spectrum analyzer display bears a similarity to the graph of the computed Fourier transform, the vertical lines within the envelope are often considered as modulation frequency components, (spectral lines) of the pulse-repetition frequency (PRF). In reality they are not; they are time dependent and provide a measurement of the pulse-repetition period of the RF carrier. This can easily be verified by noting the lack of change of horizontal spacing between lines as the dispersion of the spectrum analyzer is changed.

In comparison, if the dispersion is decreased to a small amount or shut off entirely and the sweep time changed with the sweep generator operating in a triggered mode, it will be seen that the spacing between the vertical lines will increase as the sweep time is decreased. Operating the sweep-time (time-base) generator in the calibrated triggered mode will allow measurement of the pulse repetition period which is the inverse of the pulse repetition

frequency:  $T = \frac{1}{\text{PRF}}$ .



DISPERSION = 1MHz/DIV  
 RESOLUTION = >100kHz (CW)  
 BAND = A  
 RF CENTER FREQUENCY = SAME AS TYPE 191

Fig. 2-7. Generating a pulsed RF spectrum using commercially available equipment.

spectrum  
width vs  
pulse  
duration

A pulsed RF carrier signal can easily be generated using the Tektronix instruments shown in Fig. 2-7. The output signal may be monitored on a wideband oscilloscope to show the relationship between RF pulse duration and RF spectrum width. The output waveform that is generated provides an excellent test signal to study the characteristics of the RF spectrum discussed above.

Most explanations of pulsed RF spectra are described by considering perfectly rectangular RF pulses free of AM or FM components (Fig. 2-8A). However many RF spectra are generated with RF pulses of different waveshape; some of the more common RF spectra are shown in Fig. 2-8 with accompanying interpretations<sup>1</sup>.

<sup>1</sup>A detailed discussion of these spectra will be found in Montgomery *Technique of Microwave Measurements*, Radiation Laboratory Series, Vol. XI, McGraw-Hill.

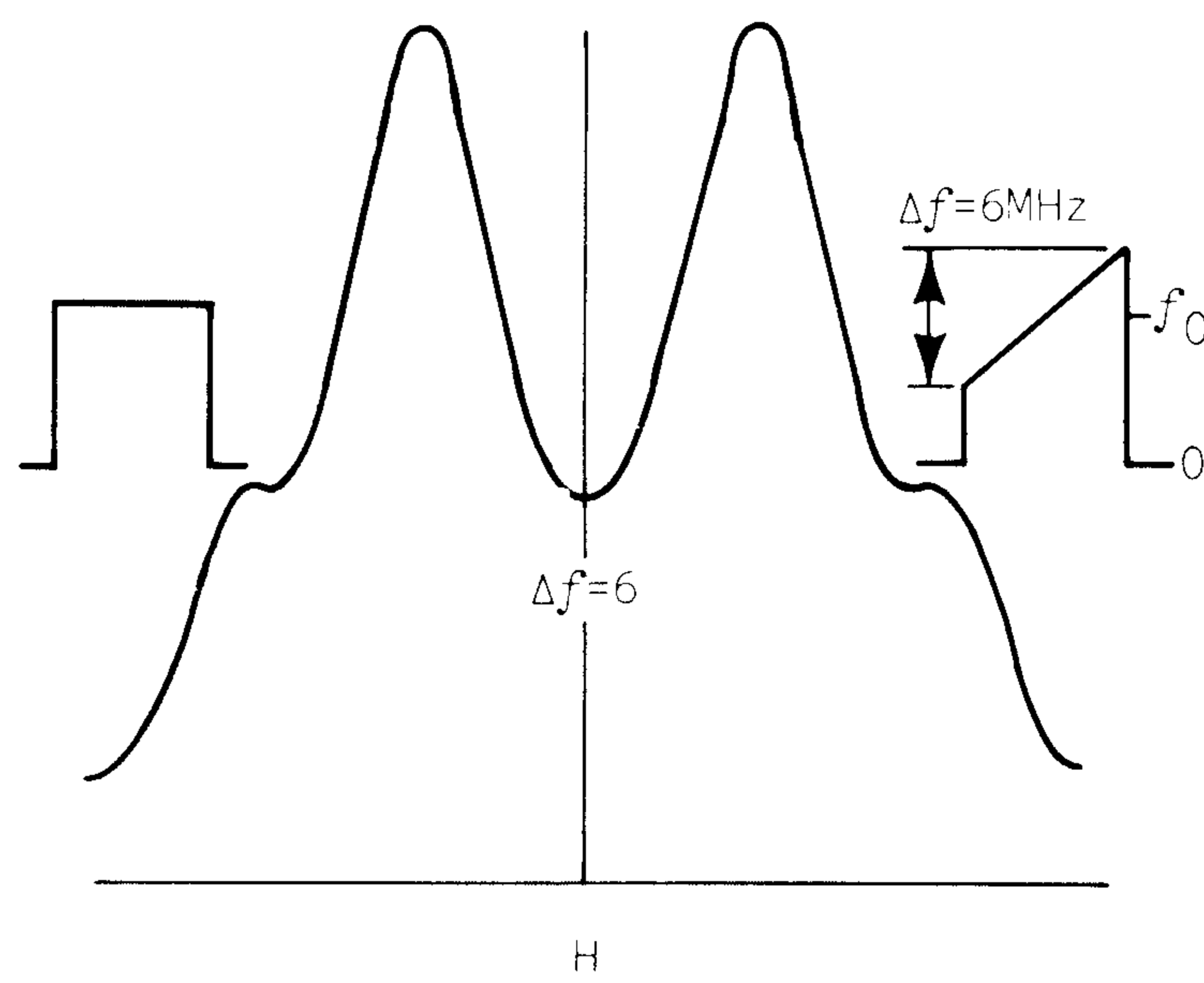
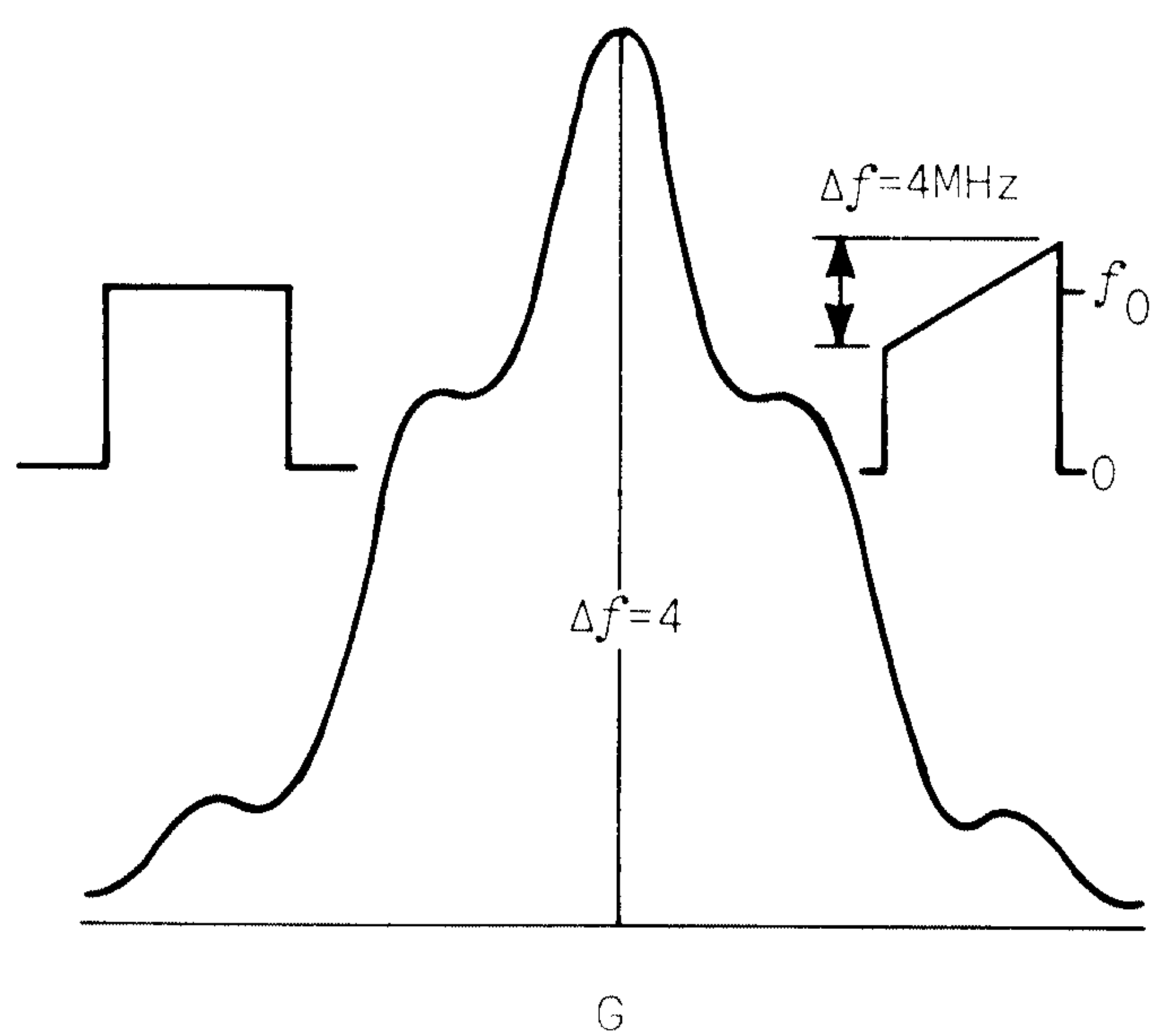
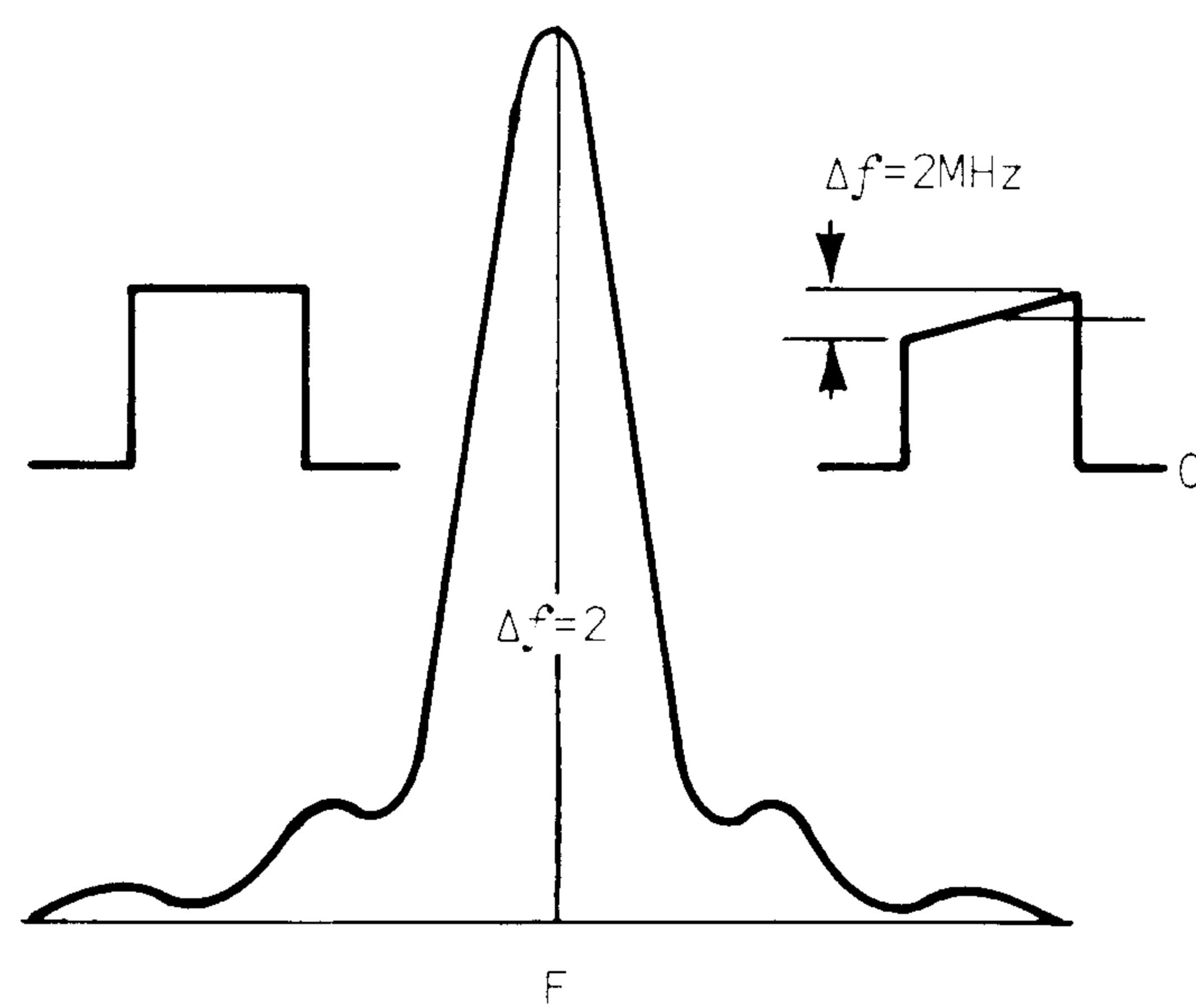
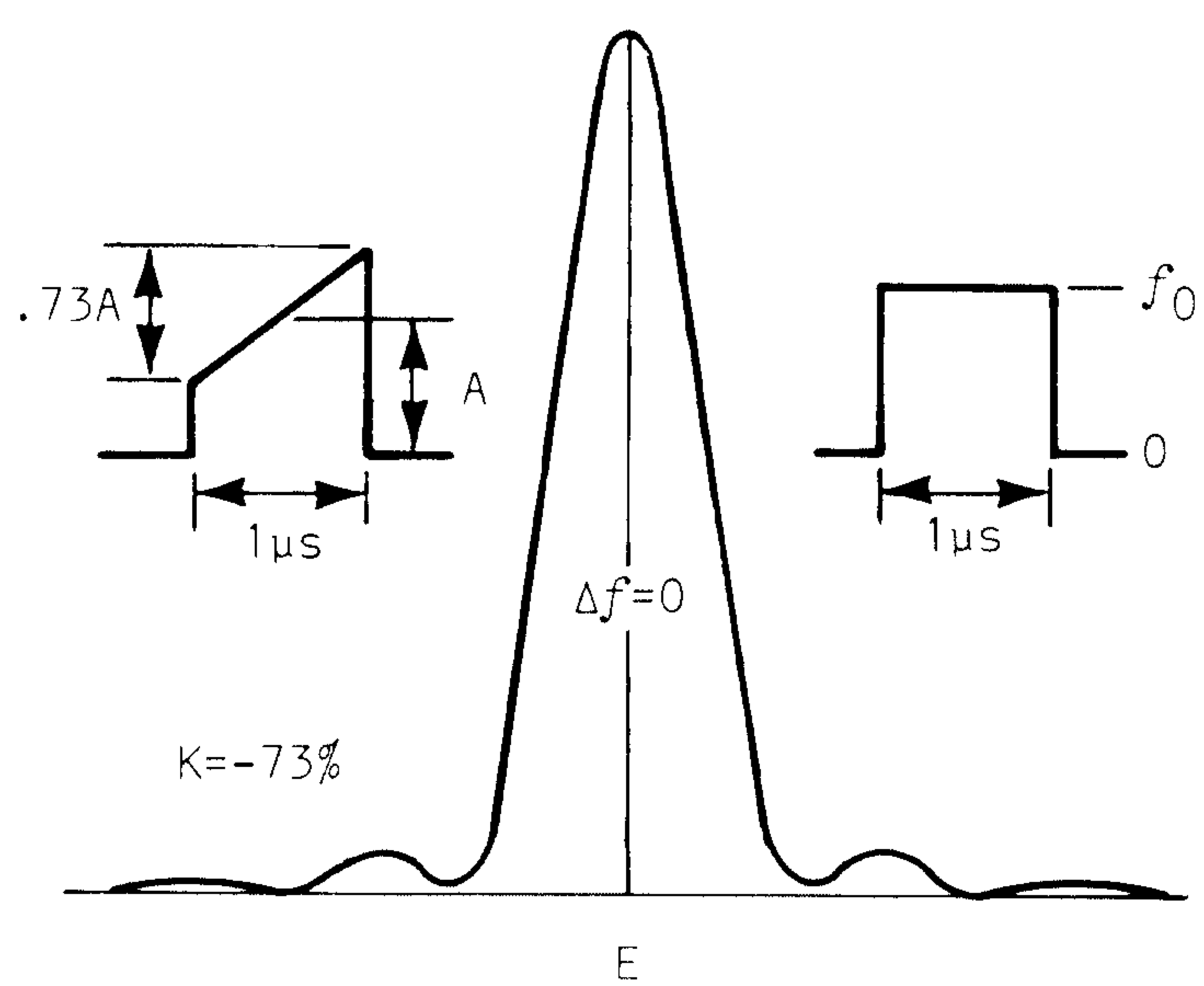
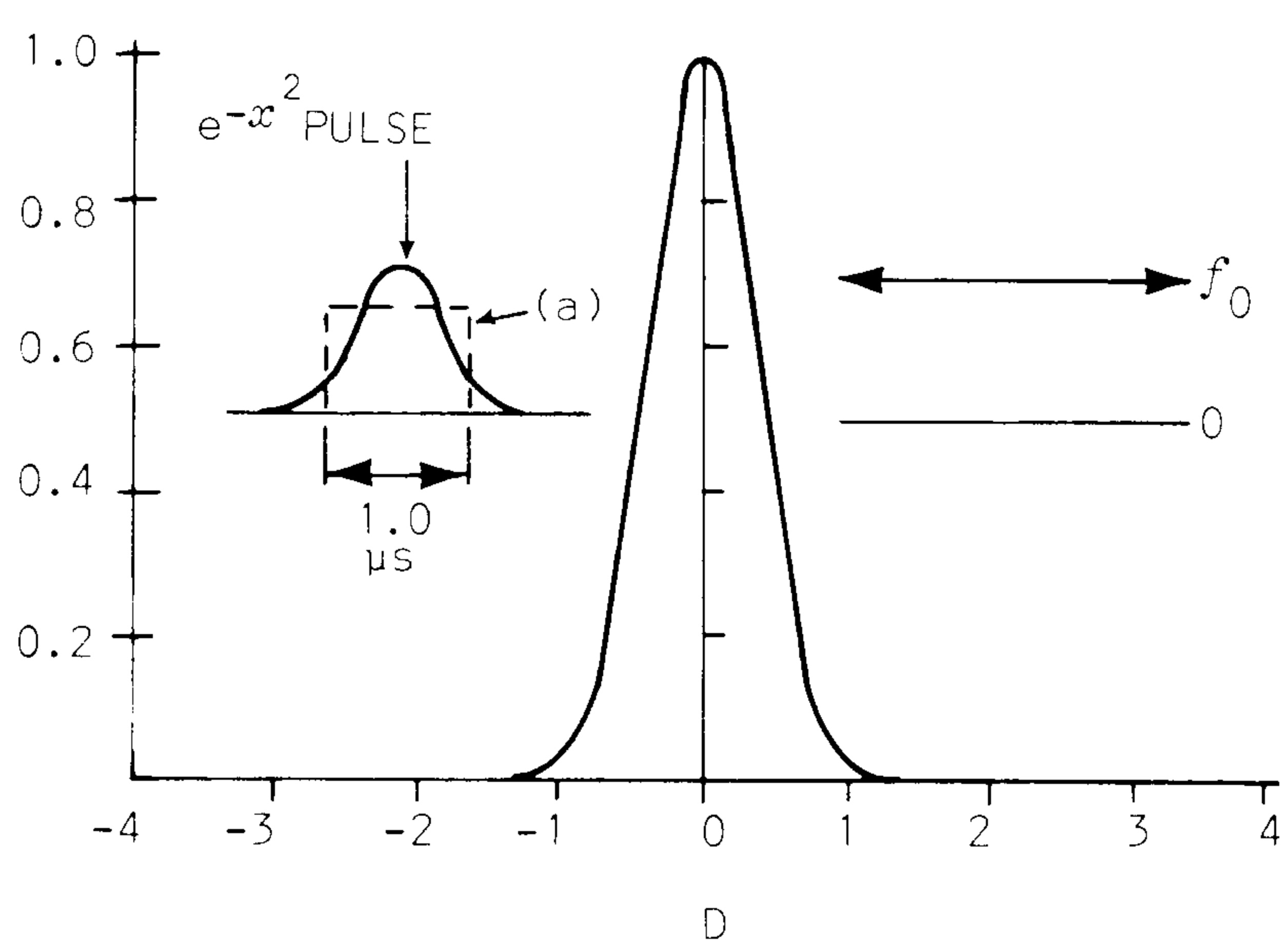
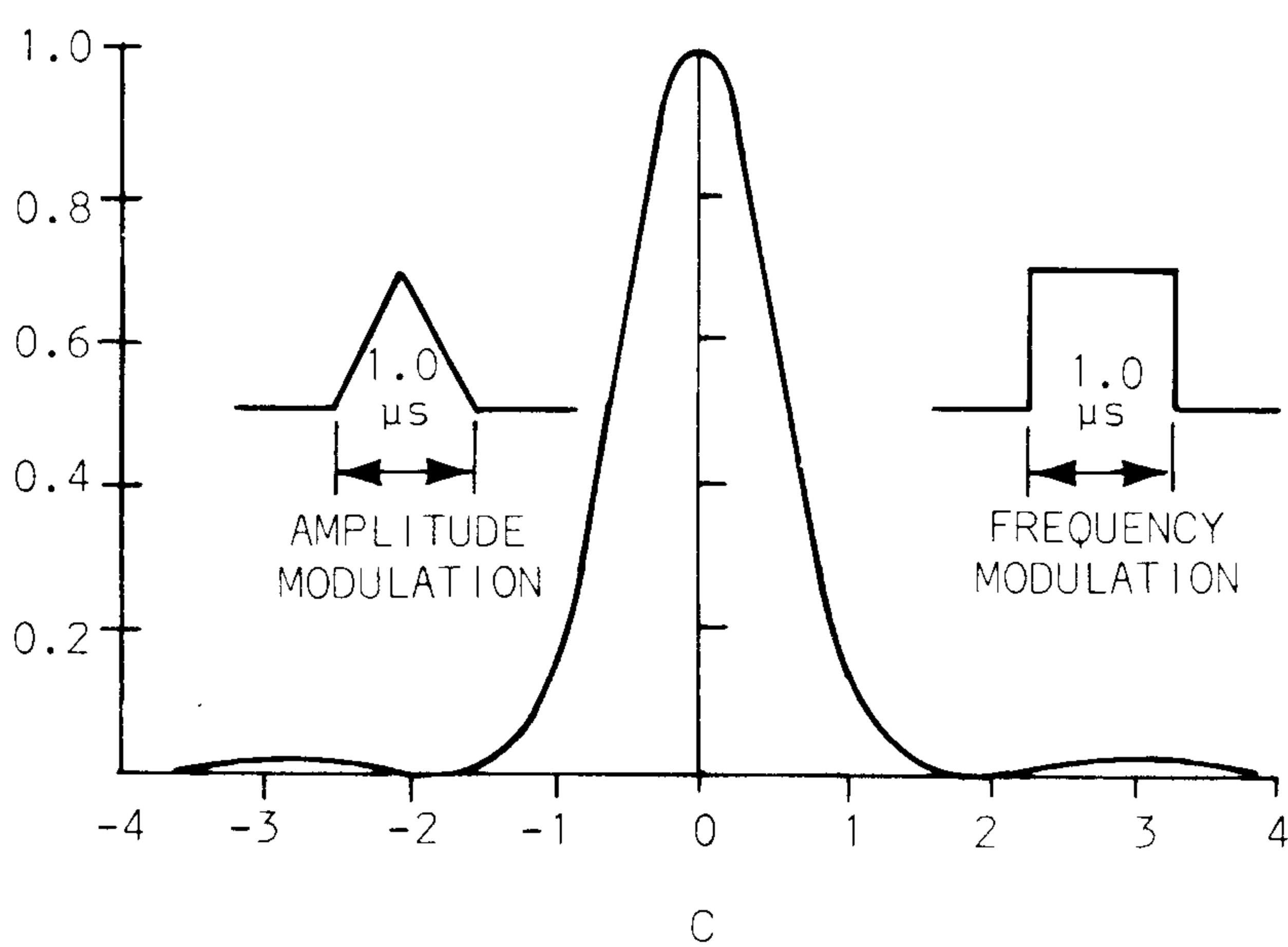
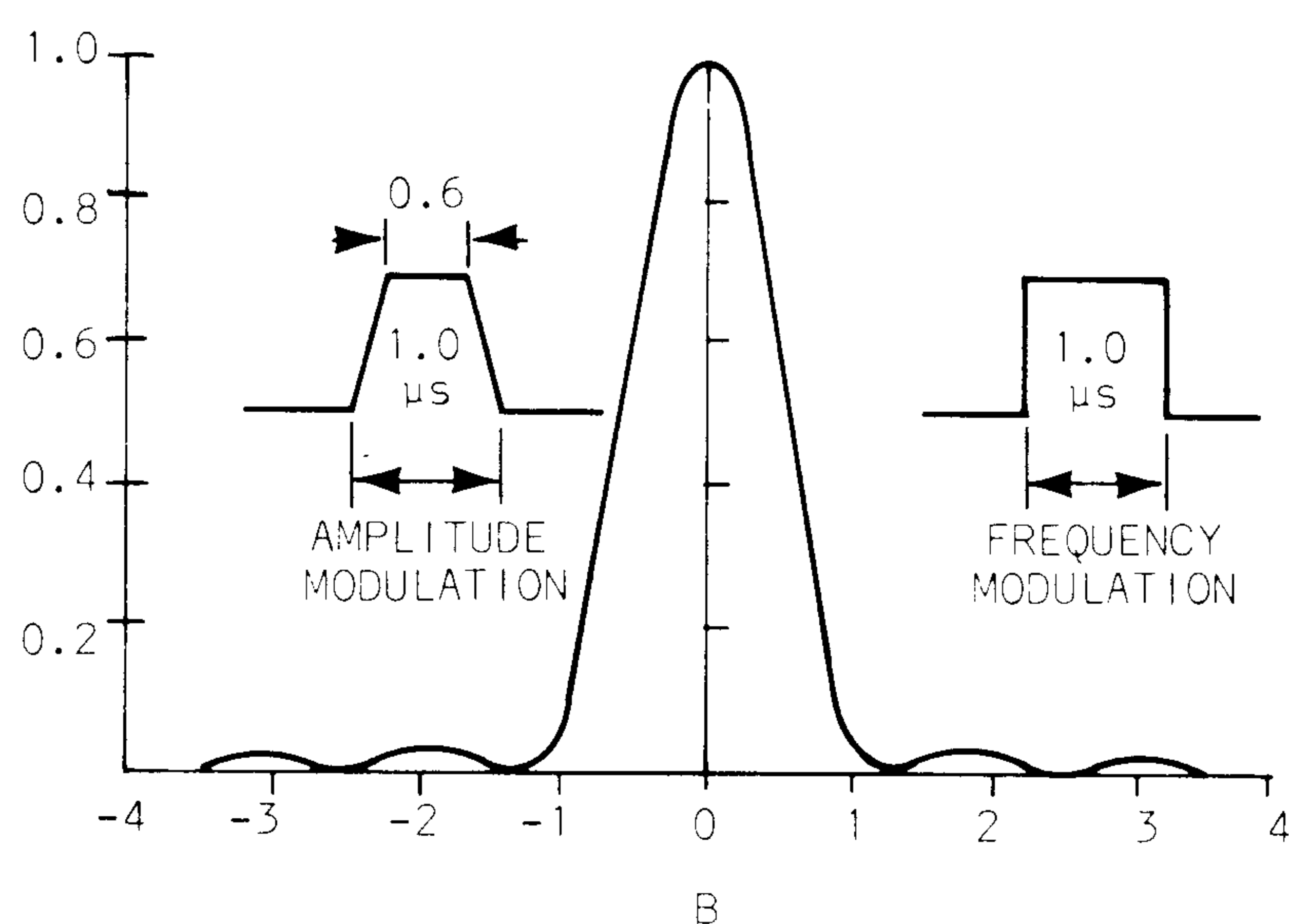
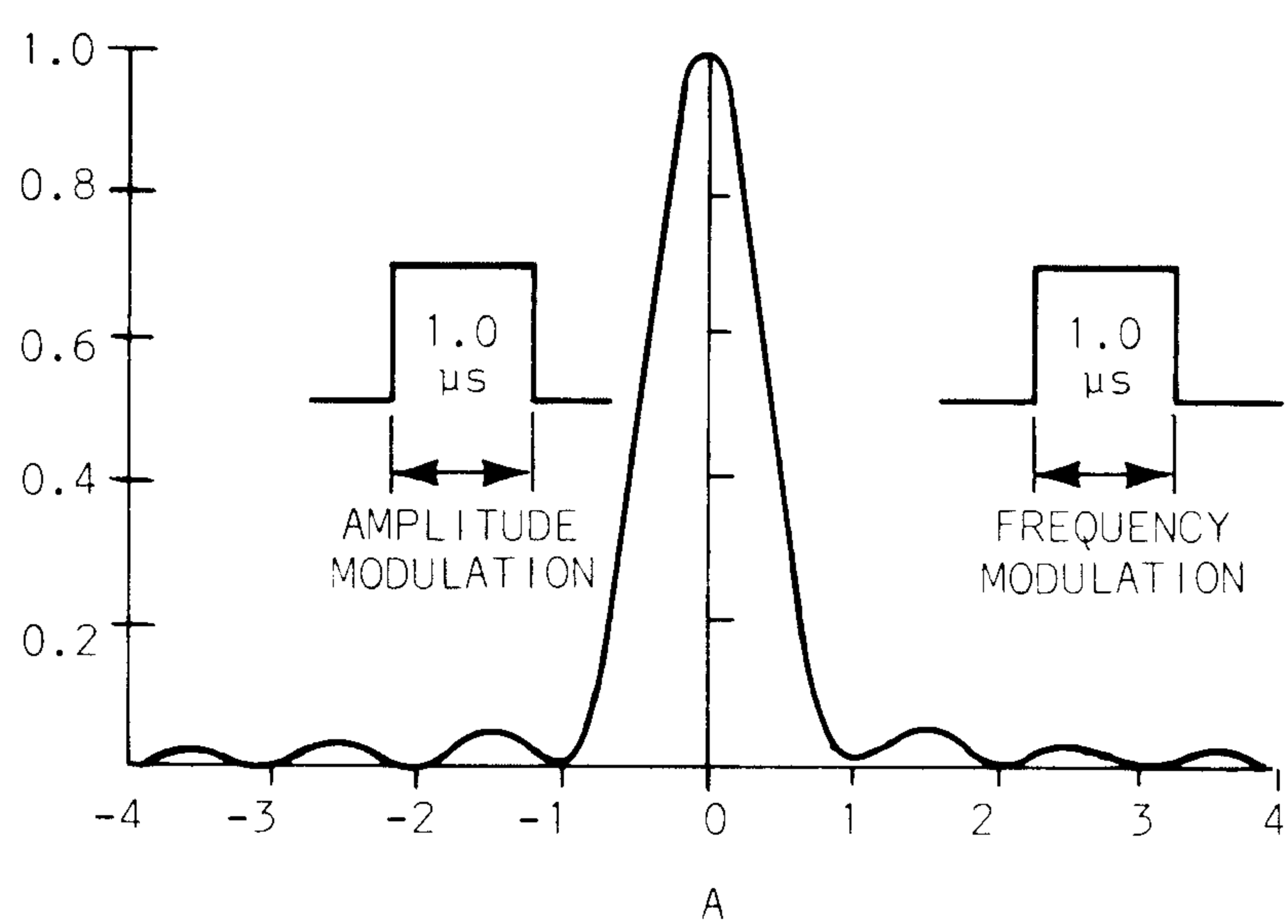


Fig. 2-8. Common RF spectra.

RF power  
spectrum

All figures are shown as they would appear in the vertical square-law mode of display which illustrates the RF power spectrum. This mode of display shows the comparative amounts of energy present in the major and minor lobes. The shape of the amplitude-modulation component of the RF carrier pulse is shown to the left of the spectrum envelope using a one-microsecond pulse. The presence of linear FM on the carrier frequency is illustrated by either an increasing or decreasing slope on the top of the pulse waveform to the right of the spectrum.

Fig. 2-8B represents the RF power spectrum of a symmetrical trapezoidal-shaped RF carrier pulse. The sloping sides tend to shorten the duration of the pulse. Shorter duration pulses generate a wider lobe structure which results in the lobe minima being spread further apart. The most significant change occurs in the reduction of amplitude in the minor or side lobes relative to the major or central lobe.

Fig. 2-8C represents the RF power spectrum of a symmetrical triangular-shaped RF carrier pulse. The increased slope of the sides of the pulse effectively shorten its duration in comparison to a rectangular pulse and therefore the lobe minima are spread much further apart than before. The side lobe amplitude decreases to practically zero.

Fig. 2-8D represents the RF power spectrum of a symmetrical gaussian-shaped RF carrier pulse which generates an RF spectrum with the same amplitude and major lobe bandwidth as an equivalent energy rectangular pulse. The RF spectrum in this case is unique since the envelope of the RF spectrum possesses the same form as the RF pulse shape. The spectrum contains no side lobes, all of the energy being concentrated in the major or central lobe.

The effect of a linearly-sloping amplitude-modulated pulse of RF carrier alone on the RF spectrum is to raise slightly the minima of the minor lobes from zero as shown in Fig. 2-8E.

The presence of FM in the RF carrier raises the lobe minima away from the zero amplitude level and therefore places more of the total energy in the minor lobe structure. This means that there is less energy present in the major lobe. As the frequency modulation is increased, the secondary lobe maxima



rise until the major lobe is engulfed, creating two peaks rather than one. With higher modulation three or more pairs of prominent peaks may exist with the result that very little energy is located in the central region of the RF power spectrum. The spectra remain symmetrical and would be unchanged whether the FM were decreasing or increasing in frequency. Such spectra are shown in Figs. 2-8F, 2-8G and 2-8H.

The physical interpretation of a pulsed spectrum has been a matter of controversy during recent years and has not been decisively resolved. Most interpretations of the pulsed envelope spectrum tend to relate to mathematical (Fourier) concepts whereas there is some evidence that the spectrum is a result of the method used to detect and display the RF pulsed spectrum<sup>1</sup>. In either case the information presented on the CRT of the spectrum analyzer is useful in determining the modulation characteristics of the pulsed RF carrier.

frequency  
modulation  
(FM)

instantaneous  
amplitude  
vs  
frequency  
deviation

In frequency modulation systems, the frequency of the RF carrier is caused to change above and below its normal RF center frequency in accordance with the *amplitude* of the modulating frequency. When the modulating signal is applied, the carrier frequency is increased during one-half cycle of the modulating frequency and decreased during the half cycle of the opposite polarity. The change in carrier frequency from its normal center frequency is called frequency *deviation*. It is essentially proportional to the instantaneous amplitude of the modulating frequency, so the deviation is usually small when the instantaneous amplitude of the modulating signal is small, and is usually greatest when the modulating frequency reaches a peak of either positive or negative polarity. The rapidity with which these deviations occur are directly related to the modulation frequency.

---

<sup>1</sup>R. W. Cushman, "Report No. NADC-EL-6452", February 15, 1965.

phase  
modulation  
(PM)

If the phase of the current in a circuit is changed, the phase lead or lag increases or decreases the period of the RF carrier. This results in an instantaneous frequency change during the time that the phase is being shifted. The amount of frequency change or deviation depends on how rapidly the phase shift is accomplished. It is also dependent upon the total amount of the phase shift. The amount of phase shift is essentially proportional to the instantaneous amplitude of the modulating signal. The rapidity of the phase shift is directly proportional to the frequency of the modulating signal. Consequently the frequency deviation in a phase-modulation system is proportional to both the amplitude and frequency of the modulating signal.

FM and PM  
comparison

The main difference between FM and PM therefore, is that frequency deviation in FM systems is determined only by the amplitude of the modulating signal whereas in PM systems the frequency deviation is determined by both the amplitude and frequency of the modulating signal.

FM and PM  
sidebands

In AM systems only a pair of sidebands spaced about the RF carrier are generated for each modulating frequency. FM and PM generate additional sidebands for each modulating frequency spaced both above and below the RF carrier (Fig. 2-9). The number of significant sidebands depend upon the relationship between the modulating frequency and the RF carrier frequency deviation. In frequency modulation the ratio between the frequency deviation and the modulating frequency is called the *modulation index*:

$$\text{Modulation index} = \frac{\text{Carrier frequency deviation}}{\text{Modulation frequency}}$$

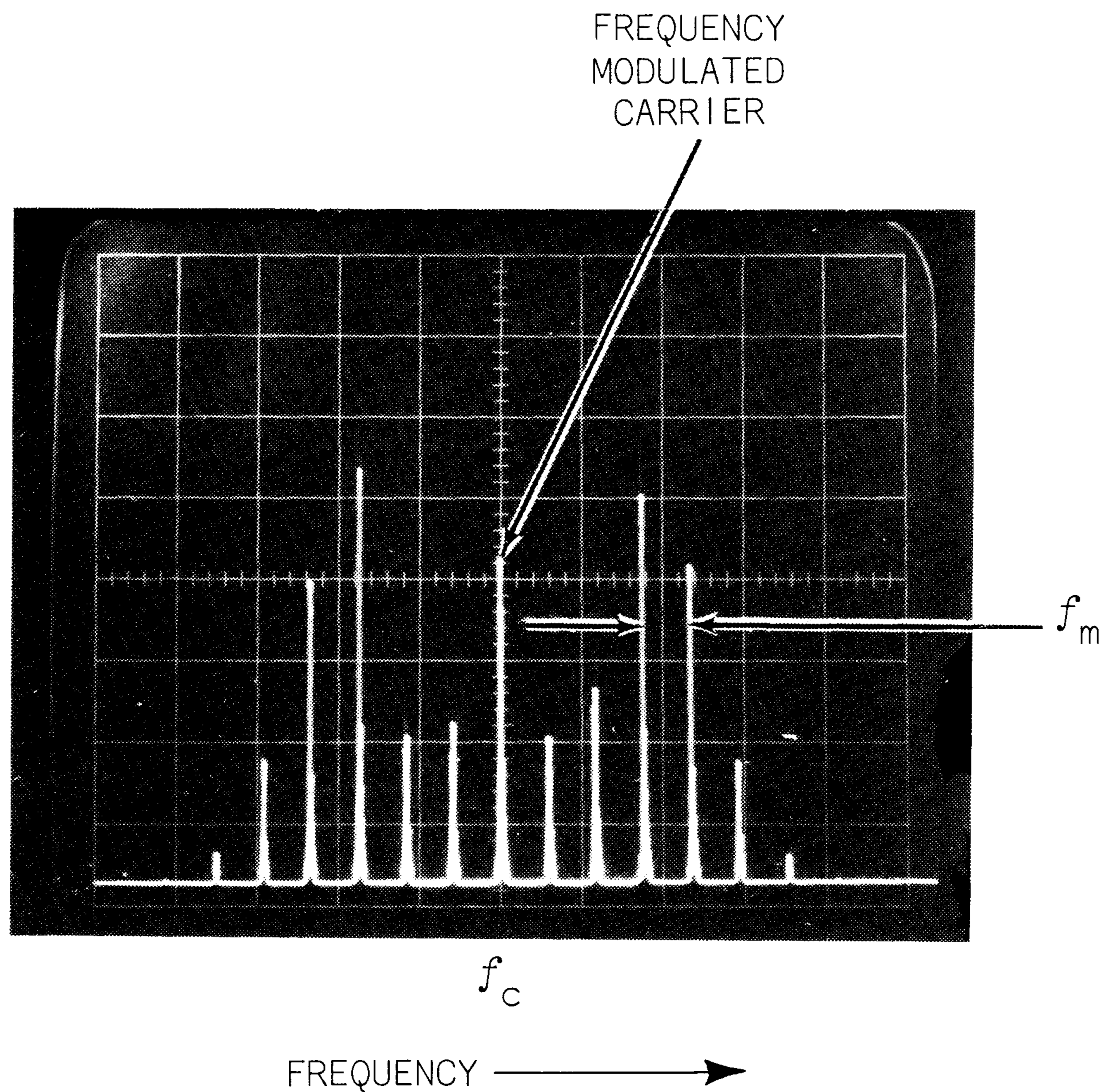


Fig. 2-9. Spectrum of a single audio tone ( $f_m$ ) frequency-modulated signal showing distribution of sidebands.

amplitude  
vs  
sidebands

As the amplitude of the modulation signal increases, the carrier deviation increases. The above equation indicates that the magnitude of the modulation index also increases as the amplitude of the modulation increases. As the amplitude of the modulation increases, more sidebands of substantial amplitude are generated. Obviously a limit to signal bandwidth must be reached, otherwise FM signals would occupy excessive amounts of RF spectrum. Maximum permissible deviation for different classes of FM service has been standardized by the Federal Communications Commission in the United States. Similar regulations are enforced throughout other countries in the world. For a specific class of service the modulation index which results from using both the highest permissible modulating frequency and widest frequency deviation is called the *deviation ratio*.

deviation  
ratio

While FM does not conserve the RF spectrum, it provides advantages not available with amplitude-modulation systems.

FM removes  
AM  
interference

Both natural (static) and man-made electrical interference is of an amplitude-modulation nature. Frequency modulation is relatively immune to interference since the amplitude variations caused by most interference does not alter the frequency which is the information-bearing characteristic of the signal.

The power in a transmitted FM signal does not vary as the modulation changes. The power is distributed between the carrier and the various pairs of sidebands.

Frequency modulation is used extensively in telemetry systems, mobile communications, and broadcast radio and television.

pulse  
modulation

Pulse modulation, sometimes termed *multipulse*, refers to a method of modulation which alters the amplitude, width, position, or code sequence of a chain of pulses in accordance with the modulating signal. This type of modulation is used to enhance signals in the presence of noise and to increase the capacity of communication circuits through the use of time-division multiplex. Since the pulse characteristics are continually changing, the frequency components of the signal are also changing, therefore, analysis of these signals is extremely difficult and is generally performed in the time domain, or by "gating" out selected pulses from within a pulse train and studying the spectrum generated by these selected pulses. The principles involved are similar to those associated with pulsed RF displays and measurements.



## 3

## SPECTRUM ANALYZER TERMS

The performance of spectrum analyzers is often described through the use of widely accepted terms. These terms generally define a function performed within the analyzer or describe a phenomena which may occur within the analyzer. Although the terms are identified individually, their effect on a display is interrelated. The relationship may often require a compromise of analyzer control settings to obtain a satisfactory display in making a specific measurement. The following list of terms and definitions are used by Tektronix to describe spectrum analyzer performance.

*Center Frequency (radio frequency or intermediate frequency)* -- That frequency which corresponds to the center of the reference coordinate.

*Center Frequency Range (radio frequency)* -- That range of frequencies that can be displayed at the center of the reference coordinate. When referred to a control (e.g., Intermediate Frequency Center Frequency Range) the term indicates the amount of frequency change available with the control.

*Dispersion (sweep width)* -- The frequency sweep excursion over the frequency axis of the display. Can be expressed as frequency/full frequency axis or frequency (Hz/div) in a linear display.

*Display Flatness* -- Uniformity of amplitude response over the rated maximum dispersion (usually in units of dB).

*Drift (frequency drift) (stability)* -- Long term frequency changes or instabilities caused by a frequency change in the spectrum analyzer's local oscillators. Drift limits the time interval that a spectrum analyzer can be used without retuning or resetting the front panel controls (units may be Hz/sec, Hz/°C, etc.).



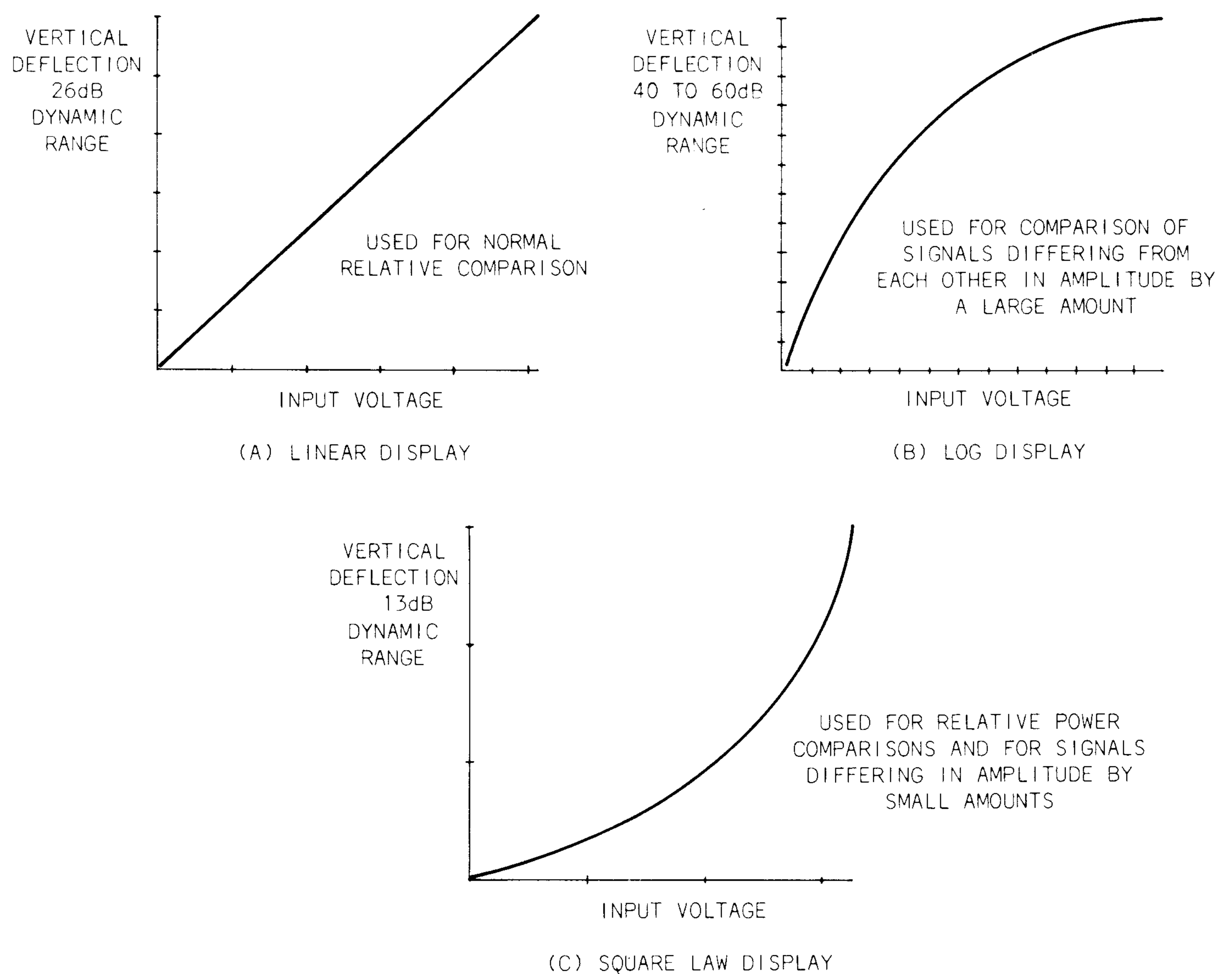


Fig. 3-1. Dynamic range.

*Dynamic Range, maximum useful* -- The ratio between the maximum input power and the spectrum analyzer sensitivity (usually in units of dB).

*Dynamic Range (on screen)* -- The maximum ratio of signal amplitudes that can be simultaneously observed within the graticule (usually in units of dB). See Fig. 3-1.

*Frequency Band* -- A range of frequencies that can be covered without switching.

*Frequency Scale* -- The range of frequencies that can be read on one line of the frequency indicating dial.

*Frequency Synthesizer* -- A device that translates the output of a precision frequency standard to another frequency or frequencies.

*Incidental Frequency Modulation (residual frequency modulation)* -- Short term frequency jitter or undesired frequency deviation caused by instabilities in the spectrum analyzer's local oscillators. Incidental frequency modulation limits the usable resolution and dispersion (in units of Hz).

*Incremental Linearity* -- A term used to describe local aberrations seen as non-linearities for narrow dispersions.

*Linear Display* -- A display in which the vertical deflection is a linear function of the input signal voltage.

*Linearity (dispersion linearity)* -- Measure of the comparison of frequency across the dispersion to a straight line frequency change. Measured by displaying a quantity of equally spaced (in frequency) frequency markers across the dispersion and observing the positional deviation of the markers from an idealized sweep as measured against a linear graticule. Linearity is within  $\Delta W \times 100\%$  where  $\Delta W$  is maximum positional W deviation and W is the full graticule width.

*Local Oscillator Radiation* -- Since the input circuit of most microwave spectrum analyzers is without any selectivity or frequency discrimination, it is easy to understand that the local oscillator signal does not receive any significant attenuation between the RF mixer and the input terminal. The local oscillator (LO) frequency present at the input terminal will in the majority comprise the fundamental LO frequency which will usually be above that indicated on the dial scale by an amount equal to the intermediate frequency. Due to the nonlinear impedance of the mixer circuit it is possible to have harmonics of the fundamental frequency of the LO present as well. In low frequency spectrum analyzers which provide preselection or RF amplification ahead of a double balanced mixer, LO radiation presents no problem.

*Maximum Input Power* -- The upper level of input power that the spectrum analyzer can accommodate without degradation in performance (spurious responses and signal compression). (Usually in units of dBm for example).

*Minimum Usable Dispersion* -- The narrowest dispersion obtainable for meaningful analysis. Defined as ten times the incidental frequency modulation when limited by "incidental frequency modulation." (in units of Hz).

*Optimum Resolution* -- The best resolution obtainable for a given dispersion and a given sweep time, theoretically: (in units of Hz)

$$\text{optimum resolution} = \sqrt{\frac{\text{dispersion (in Hz)}}{\text{sweep time (in seconds)}}}$$

*Optimum Resolution Bandwidth* -- The bandwidth at which best resolution is obtained for a given dispersion and a given sweep time as per: (in units of Hz)

$$\text{optimum resolution bandwidth} = 0.66 \sqrt{\frac{\text{dispersion}}{\text{sweep time}}}$$

*Phase Lock* -- The synchronization of the local oscillator with a stable reference frequency.

The accuracy and resolution capability of spectrum analyzers are dependent upon the stability of their local oscillator frequency. A method technically referred to as phaselock is used to improve the stability of local oscillators. It synchronizes the LO frequency to that of a stable frequency reference thereby improving its frequency stability.

Phaselock frequency stability results in a lower value of incidental FM and display frequency drift associated with the local oscillator. This increases the performance capability of the spectrum analyzer to separate closely spaced signals within the RF spectrum as well as adding measurably to the ability of performing the measurement.

*Picket fence* -- A term used to describe a display of frequency markers on a frequency base.

*Resolution* -- The ability of the spectrum analyzer to display adjacent signal frequencies discretely. The measure of resolution is the frequency separation of two equal amplitude signals, the displays of which merge at the 3-dB down points (in units of Hz). See Fig. 3-2A and 3-2B.

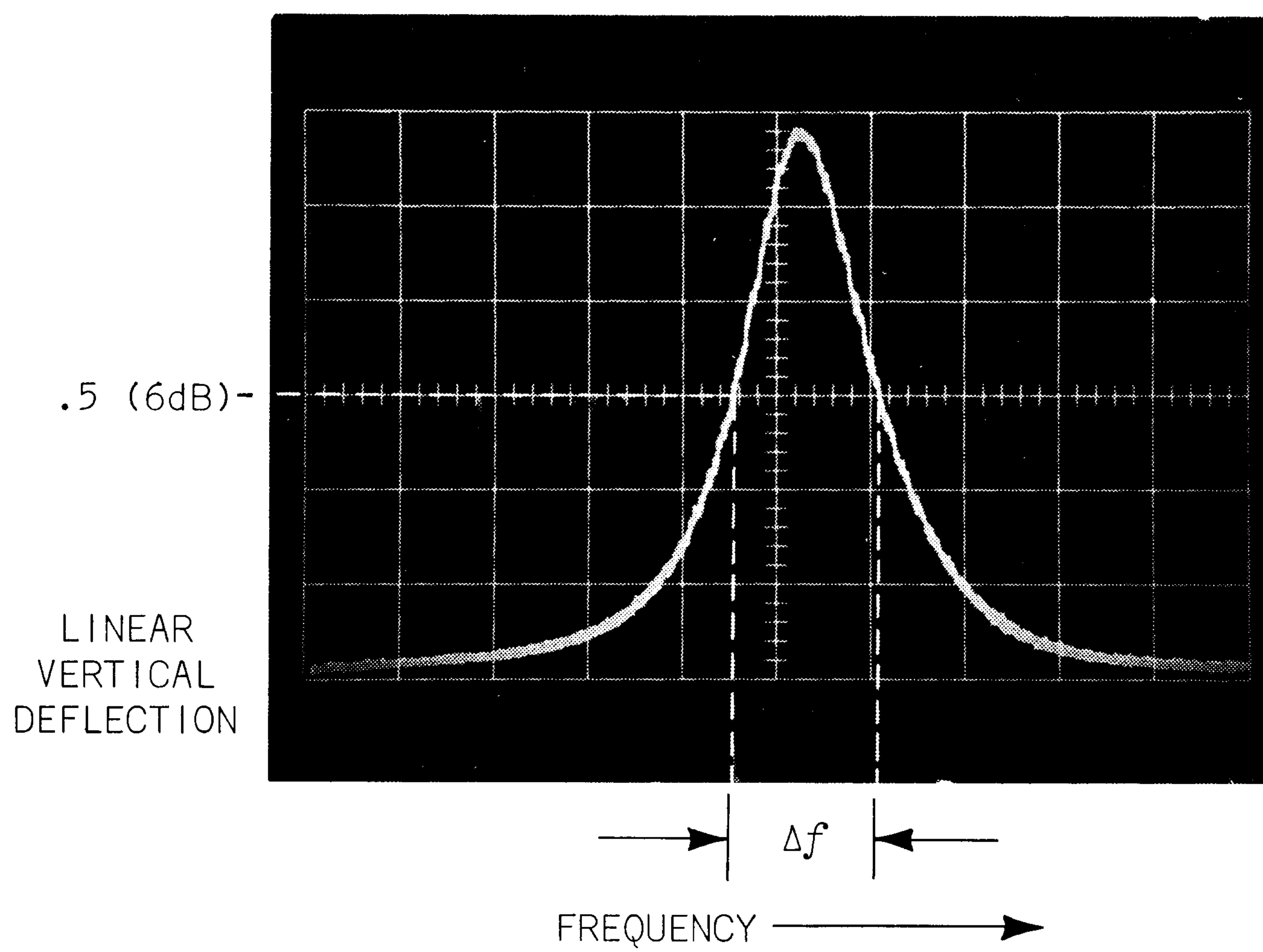
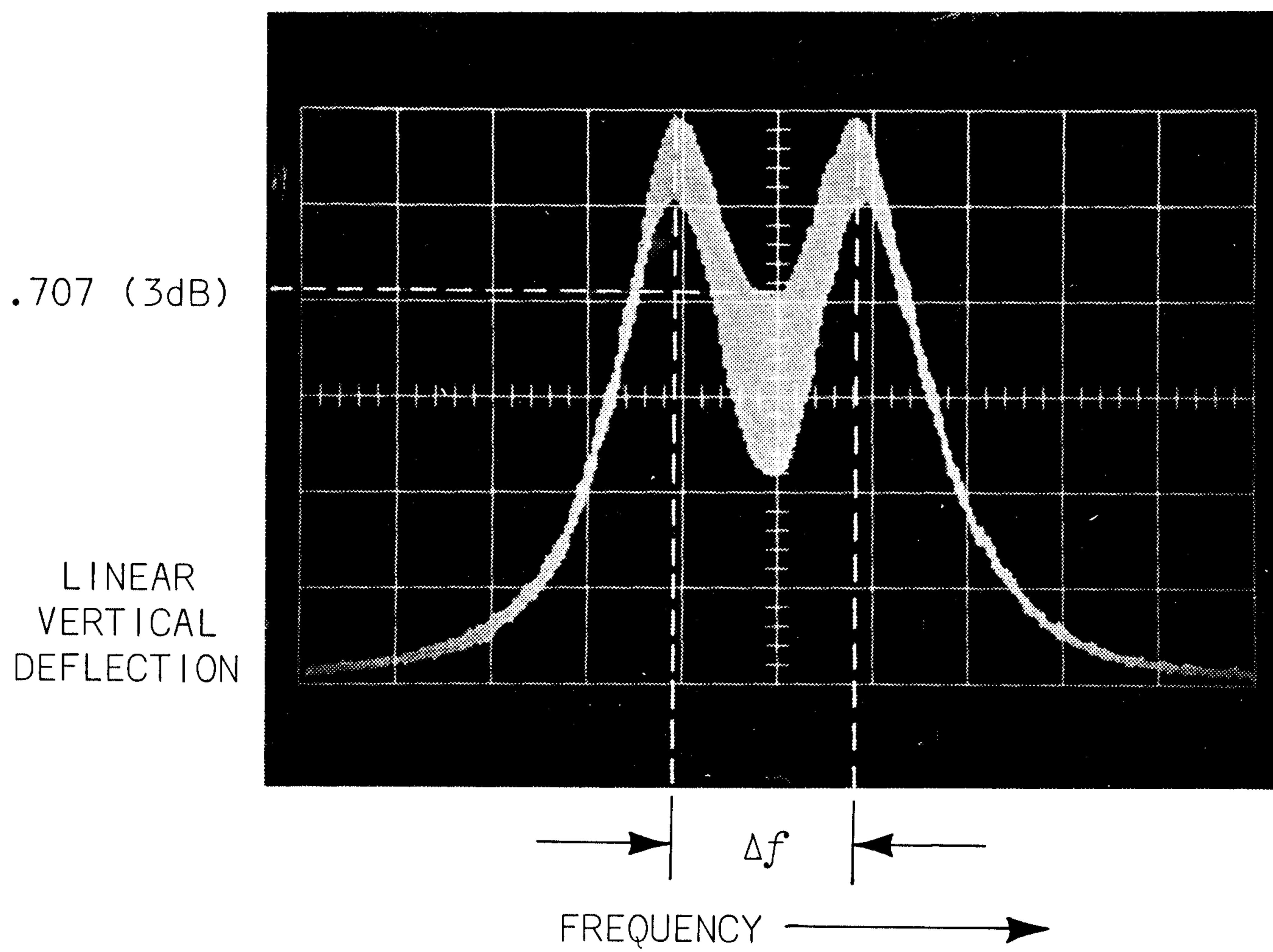
(B) ALTERNATE DEFINITION OF RESOLUTION ( $\Delta f$ )(A) RESOLUTION IS  $\Delta f$ 

Fig. 3-2. Resolution.

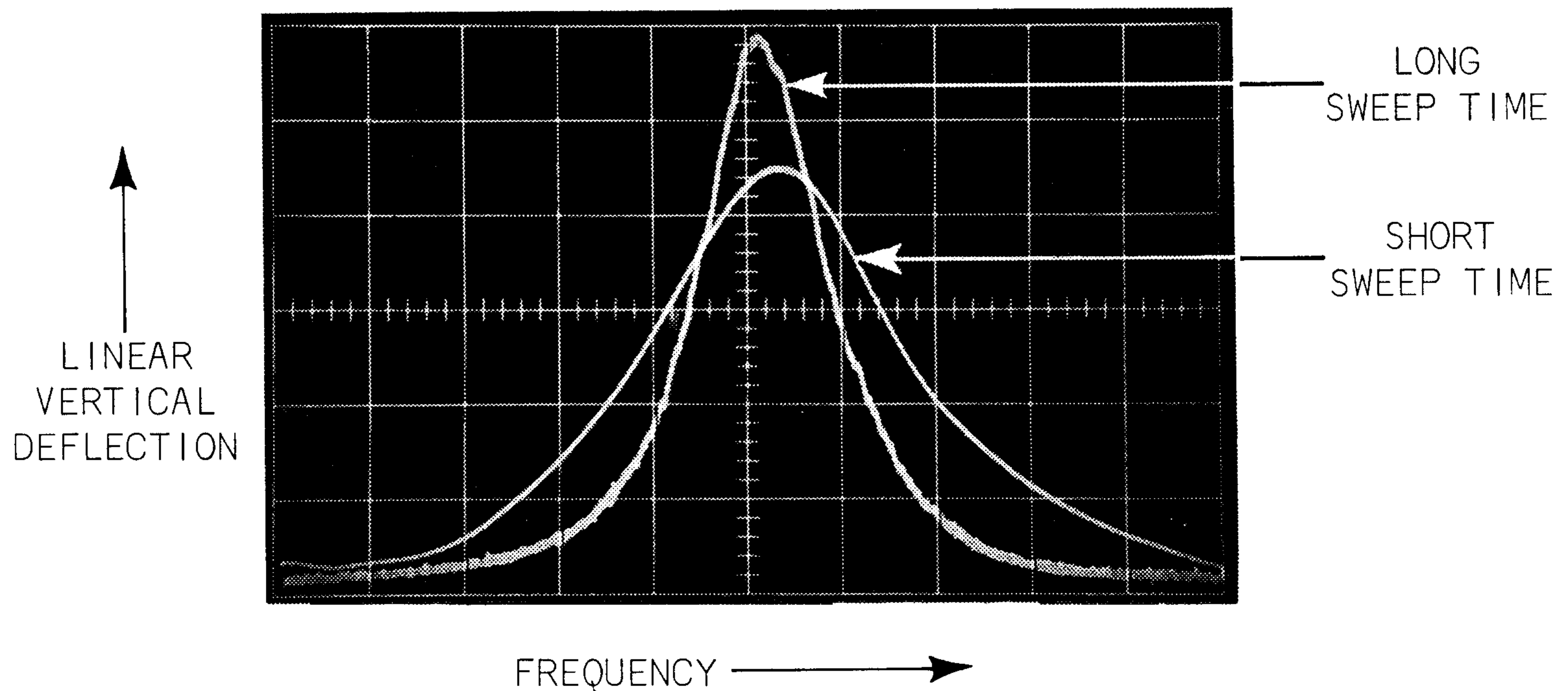


Fig. 3-3. Effect of sweep time on resolution.

The resolution of a given display depends on three factors; sweep time, dispersion and the bandwidth of the most selective amplifier. The 6-dB bandwidth of the most selective amplifier (when Gaussian) is called resolution bandwidth and is the narrowest bandwidth that can be displayed as dispersion and sweep time are varied. At very long sweep times, resolution and resolution bandwidth are synonymous. See Fig. 3-3.

*Resolution Bandwidth* -- Refer to *resolution*.

*Safe Power Level* -- The upper level of input power that the spectrum analyzer can accommodate without physical damage (usually in units of dBm).

*Scanning Velocity* -- Product of dispersion and sweep repetition rate (units of Hz/unit time).

*Sensitivity* -- Rating factor of spectrum analyzers ability to display signals.

1. Signal equals noise. That input signal level (usually in dBm) which results in a display where the signal level above the residual noise is equal to the residual noise level above the baseline; expressed as:  $\text{signal} + \text{noise} = \text{twice noise}$ .

2. Minimum discernible signal. That input signal level (usually in dBm) which results in a display where the signal is just distinguishable from the noise.



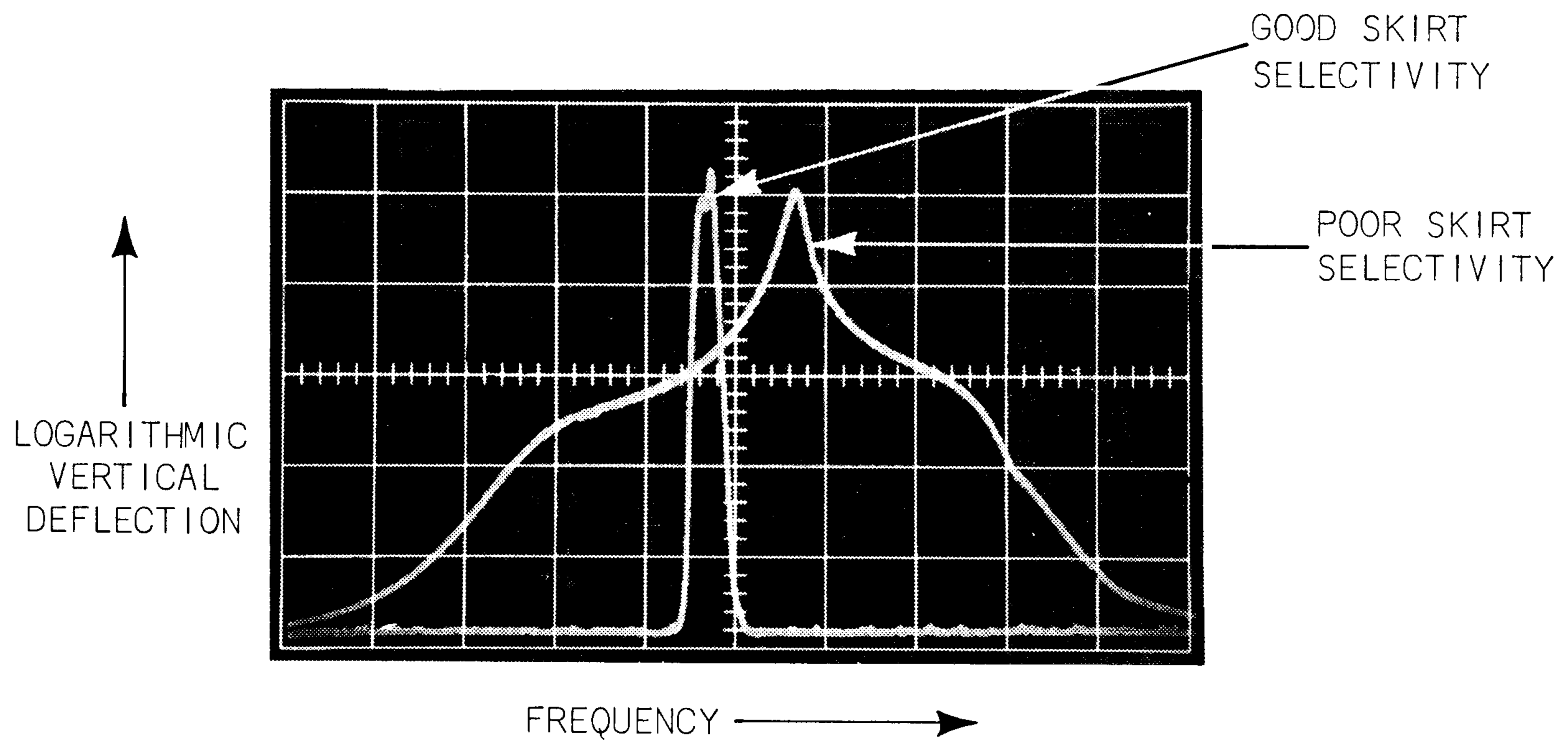


Fig. 3-4. Skirt selectivity.

*Skirt Selectivity* -- A measure of the resolution capability of the spectrum analyzer when displaying signals of unequal amplitude. A unit of measure would be the bandwidth at some level below the 6 dB down points, (e.g. 10, 20, 40 dB down). (units of dB). See Fig. 3-4.

*Spectrum Analyzer* -- A device which displays a graph of relative power distribution as a function of frequency, typically on a cathode ray tube or chart recorder.

A. Real Time. A spectrum analyzer that performs a continuous analysis of the incoming signal with the time sequence of events preserved between input and output.

B. Non-Real Time. A spectrum analyzer that performs an analysis of a repetitive event by a sampling process.

1. Swept front end. A superheterodyne spectrum analyzer in which the first local oscillator is swept.

2. Swept intermediate frequency. A superheterodyne spectrum analyzer in which a local oscillator other than the first is swept.

*Spurious Responses* (spurii, spur) -- A characteristic of a spectrum analyzer wherein displays appear which do not conform to the calibration of the radio frequency dial. Spurii and spur are colloquialisms used to mean spurious responses (plural) and spurious response (singular) respectively. Spurious responses are of the following type:

A. Intermediate frequency feedthrough. Wherein signals within the intermediate frequency passband of the spectrum analyzer reach the intermediate frequency amplifier and produce displays on the cathode ray tube that are not tunable with the RF center frequency controls. These signals do not enter into a conversion process in the first mixer and are not affected by the first local oscillator frequency.

B. Image response. The superheterodyne process results in two major responses separated from each other by twice the intermediate frequency. The spectrum analyzer is usually calibrated for only one of these responses. The other is called the image.

C. Harmonic conversion. The spectrum analyzer will respond to signals that mix with harmonics of the local oscillator and produce the intermediate frequency. Most spectrum analyzer's have dials calibrated for some of these higher order conversions. The uncalibrated conversions are spurious responses.

D. Intermodulation. In the case of more than one signal, the myriad of combinations of the sums and differences of these signals between themselves and their multiples creates extraneous responses known as intermodulation. The most harmful intermodulation is third order, caused by the second harmonic of one signal combining with the fundamental of another. See Fig. 3-5.

E. Video detection. The first mixer will act as a video detector if sufficient input signal is applied. A narrow pulse may have sufficient energy at the intermediate frequency to show up as intermediate frequency feedthrough.

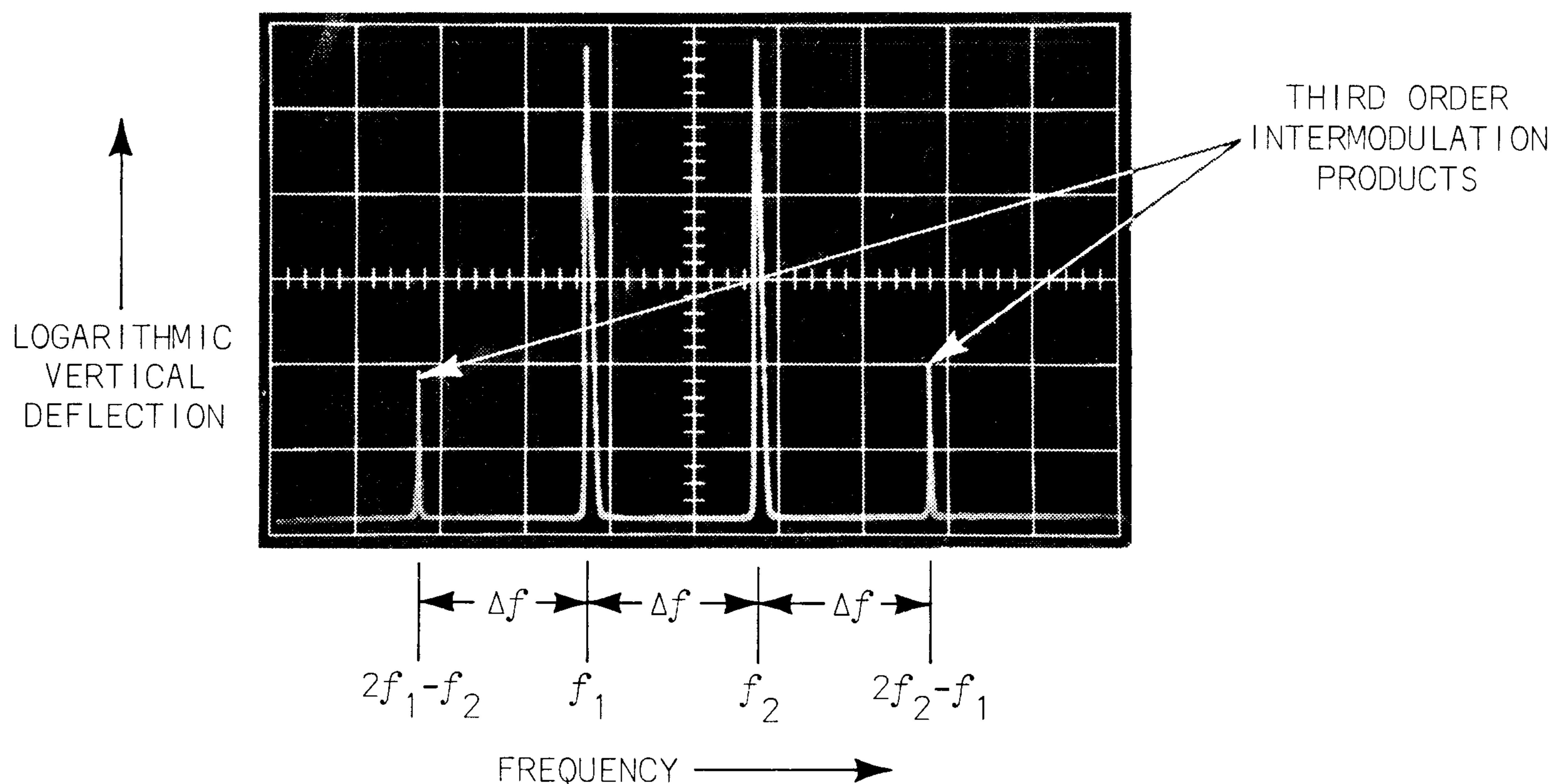


Fig. 3-5. Intermodulation.

F. Internal. A display shown on the cathode-ray tube caused by a source or sources within the spectrum analyzer itself and with no external input signal. Zero frequency feedthrough is an example of such a spurious response.

G. Anomalous intermediate frequency (IF) responses. The filter characteristic of the resolution-determining amplifier may exhibit extraneous passbands. This results in extraneous spectrum analyzer responses when a signal is being analyzed.

*Sweep Repetition Rate* -- The number of sweep excursions per unit of time. Sometimes approximated as the inverse of sweep time for a free-running sweep.

*Sweep Time* -- The time required for the spot in the reference coordinate (frequency in spectrum analyzers) to move across the graticule. (In a linear spectrum analyzer system sweep time is TIME/DIVISION multiplied by total divisions.)

*Vertical Logarithmic Display* -- A display in which the vertical deflection is a logarithmic function of the input signal voltage.

*Vertical Square Law Display* -- A display in which the vertical deflection is a linear function of the input signal power.

*Vertical Video Display* -- A mode of operating a spectrum analyzer to obtain conventional oscilloscope display of amplitude versus time.

*Zero Frequency Feedthrough* (zero pip) -- The response of a spectrum analyzer which appears when the frequency of the first local oscillator is equal to the intermediate frequency. This corresponds to zero input frequency and is sometimes not suppressed so as to act as a zero frequency marker.

## 4

SPECTRUM ANALYZER CHARACTERISTICS  
AND THEIR RELATIONSHIPS

resolution  
factors

As mentioned earlier, the resolution of a given display depends upon three factors: sweptime, dispersion and bandwidth. Not only do these factors affect the resolution, they also influence the sensitivity of the analyzer to an applied signal.

Although spectrum analyzer instrument characteristics such as resolution, sensitivity, dispersion and sweptime are usually described independently, the effect of each on the signal display indicates an interrelationship that must be considered when a signal measurement is to be performed.

The idealized spectrum display for a continuous-wave (CW) radio-frequency signal would be a vertical line of zero frequency width on the face of the cathode-ray tube representing the signal frequency, as shown in Fig. 4-1A. However, because the narrowest resolution filter still provides a finite bandwidth, the spectrum analyzer displays individual signals as pips of finite width (Fig. 4-1B). At very slow

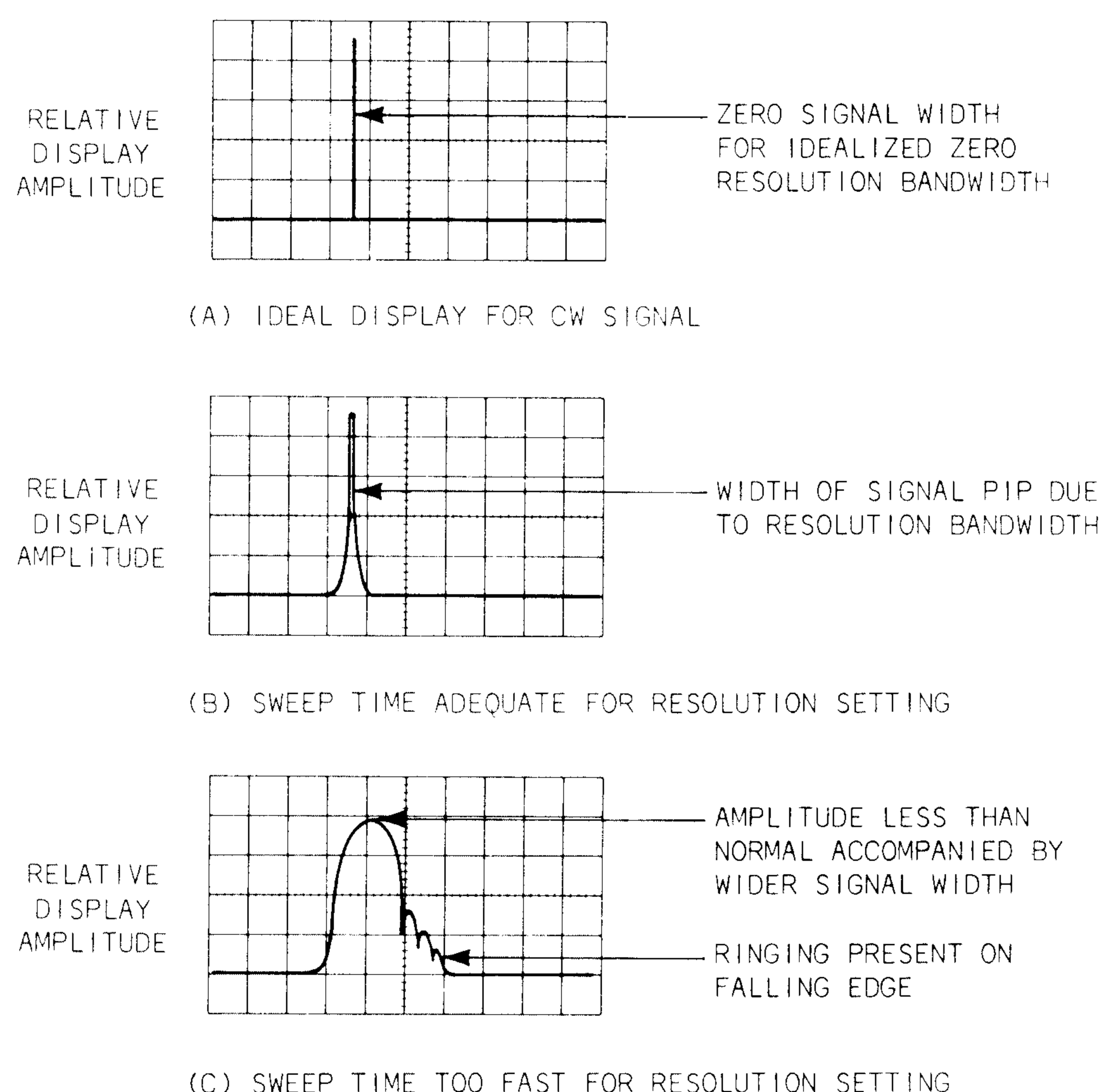


Fig. 4-1. Spectrum analyzer displays.



pip shape  
vs  
response

sweep times the shape of the pip is equal to the bandpass response curve of the resolution amplifier filter. Since the bandpass is finite, it has an associated time of response. If the sweep time is faster than this response time the filter will not be able to respond adequately and there will be a loss in amplitude proportional to the speed of the sweep accompanied by a broadening of the pip and a ringing on the falling edge of the signal display (Fig. 4-1C).

Assuming a Gaussian filter response, the loss in amplitude as a function of sweep time, resolution bandwidth and dispersion is expressed by the equation:

$$\text{Loss} = \left[ 1 + .195 \left( \frac{D}{TB^2} \right)^2 \right]^{-1/4}$$

where

$D$  = dispersion

$T$  = sweep time in seconds

$B$  = resolution bandwidth at the 3-dB down points

decrease  
sweep time  
to increase  
amplitude

The utility of the equation is to illustrate the interrelation between dispersion, sweep time, and resolution bandwidth and their effect on display sensitivity. In practice the calculation is seldom performed. All that is necessary to achieve optimum amplitude is to decrease the sweep time to the point at which the amplitude of the display remains constant. If the sweep time is decreased enough, the low display repetition frequency may result in an objectionable flicker. The annoyance may be alleviated by increasing the display repetition frequency (increase the TIME PER DIV setting) at a sacrifice in the fidelity of the signal display. A satisfactory solution often may be found in the use of a long decay (P7) phosphor or a storage-type cathode-ray tube.

decrease  
bandwidth to  
decrease  
noise

The sensitivity of the spectrum analyzer is also affected by the resolution bandwidth. The IF bandwidth of the resolution amplifier determines both the noise bandwidth and resolution capability of the spectrum analyzer. The narrower the bandwidth of the amplifier the better its ability to resolve adjacent signals in the RF spectrum. In the predominant case where most of the gain occurs ahead of the resolution-determining amplifier, the narrower

bandwidth also decreases the amount of noise energy accepted by the analyzer in comparison to that of the signal. The decrease in noise in relation to the signal energy results in an improved signal-to-noise ratio which aids in achieving maximum sensitivity. Minimum resolution bandwidth therefore provides maximum sensitivity.

In addition, another relation exists which can affect the resolution of the display. It has been shown mathematically<sup>1</sup> that for an assumed Gaussian IF response (bandwidth measured at -3 dB points) the apparent resolution  $R$  is equal to:

$$R = \left[ B^2 + 0.195 \left( \frac{D}{TB} \right)^2 \right]^{1/2}$$

where

$R$  = apparent (dynamic) resolution bandwidth

$B$  = actual (static) resolution bandwidth

$D$  = dispersion (total sweepwidth)

$T$  = time required for one sweep across  $D$ .

In examining the equation it can be seen that for a particular value of static resolution bandwidth, shortening of the sweep time will increase the dynamic or apparent resolution of the analyzer. Similarly an increase in dispersion will increase the apparent resolution bandwidth and seriously limit the practical resolution of the spectrum analyzer.

The apparent resolution bandwidth  $R$  is always greater than the zero dispersion (or static) bandwidth of the resolution amplifier. For example, given a dispersion  $D$  of 50 MHz in a time  $T$  of 1 millisecond (time per division, 0.1 ms) and a static resolution bandwidth  $B$  of 100 kHz, the resolving capability of the instrument is not 100 kHz, but

$$R = \left[ (10^5)^2 + 0.195 \left( \frac{5 \times 10^7}{10^{-3} \times 10^5} \right)^2 \right]^{1/2} = 243 \text{ kHz}$$

Confidence in the settings of a calibrated resolution bandwidth control can very easily lead to erroneous results since the dynamic resolving capability of the spectrum analyzer may be different.

---

<sup>1</sup>*Spectrum Analyzer Techniques Handbook*, Polarad Electronics, 1962.

It might be assumed from examining the equation that if the dispersion  $D$  and the time  $T$  are fixed,  $R$  can be made as small as desired simply by reducing the resolution bandwidth  $B$ . This, however, is not the case. With  $D$  and  $T$  fixed, there is only one specific resolution bandwidth  $B$  for which the apparent or dynamic resolution bandwidth  $R$  is minimum<sup>1</sup>:  $R = \sqrt{2} B$ .

Again, the utility of the equation is to describe the relationship between the various characteristics and how their individual variations can effect the display. In practice the computation is seldom performed.

The above relationships are most effective when displaying continuous wave (CW), amplitude-modulated and frequency-modulated signals. With these types of signals, the resolution of individual frequency components of the spectra is of primary importance. It also applies to pulsed RF signals but is seldom of importance because the resolution bandwidth desired is usually very much greater than that used for CW, AM and FM type signals.

---

<sup>1</sup>Engelson and Long, "Optimizing Spectrum-Analyzer Resolution," *Microwaves*, Dec. 1965.

resolution  
bandwidth  
for pulsed  
RF

The resolution bandwidth necessary to display the RF spectrum envelope of a pulsed RF carrier differs from that required to resolve the discrete frequency components associated with amplitude and frequency modulated signals as mentioned previously. Pulsed RF carriers are used extensively to generate radar signals. In radar signal analysis the envelope of the RF spectrum provides information which is indicative of the radar's performance. Therefore the need for narrow resolution beyond that required to display the spectrum null-lobe structure is unnecessary. Experimental tests conducted to determine the optimum resolution bandwidth for a given RF pulse duration has resulted in the widespread use of the equation:

$$bw \leq \frac{0.1}{T_d}$$

where

$bw$  = the -3 dB bandwidth of the resolution amplifier, expressed in Hz

$T_d$  = the duration of the RF pulse, expressed in seconds.

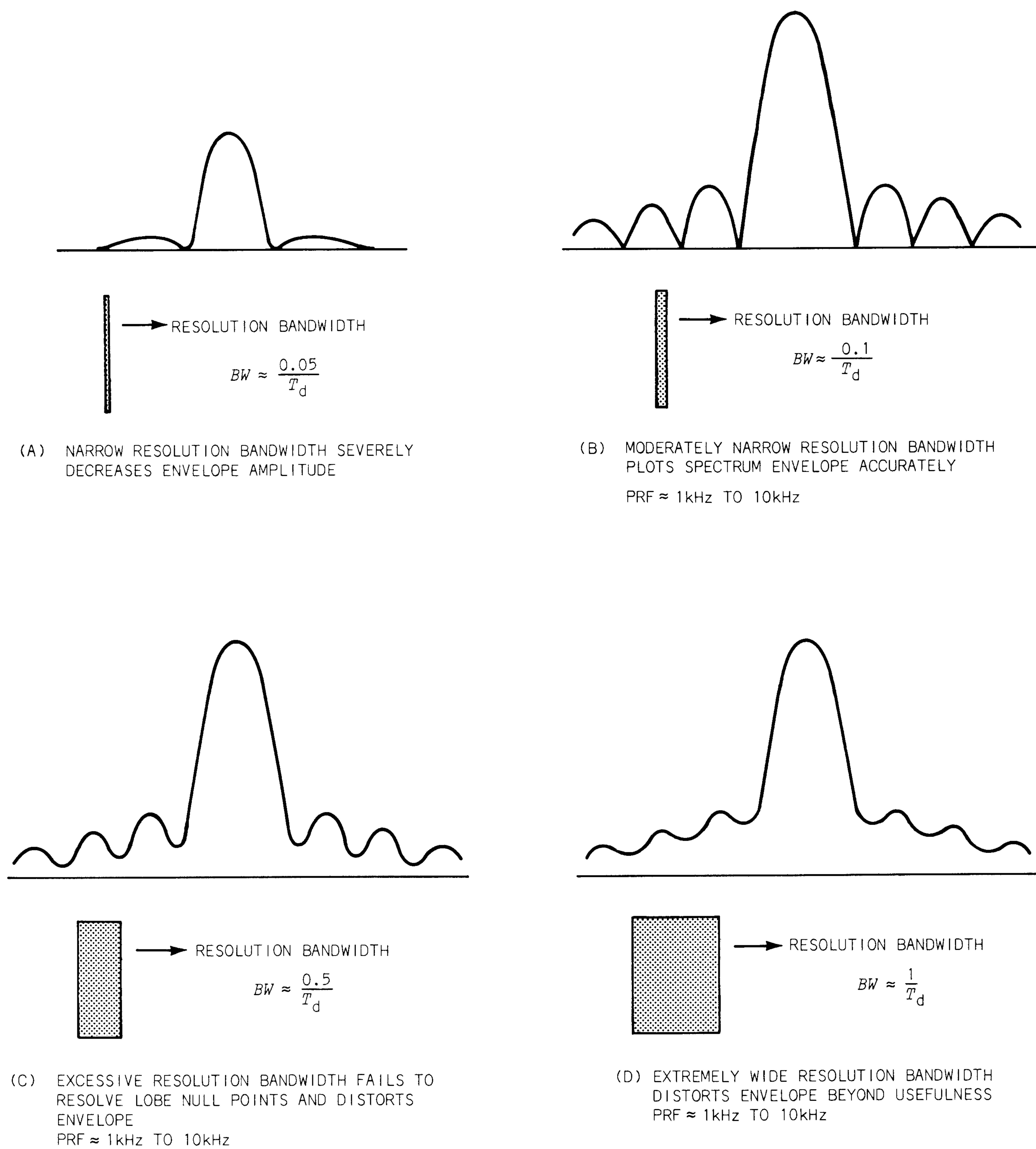


Fig. 4-2. Effects of resolution bandwidth on spectrum analyzer display.



The value of the constant 0.1 was determined empirically. Fig. 4-2 illustrates the effect of using different resolution bandwidths on the display of an RF spectrum.

From the above equation a resolution bandwidth equivalent to one-tenth of the frequency difference between the nulls of the minor lobes is satisfactory to display the pertinent detail in the spectrum structure. The utility of the equation is its illustration of relationship between resolution bandwidth and RF pulse duration rather than by its mathematical accuracy. In practice the resolution bandwidth is made as broad as possible, consistent with adequate sharp null definition for the lobes.

Fig. 4-2A shows a significant decrease in spectrum envelope amplitude when the resolution bandwidth is narrowed below optimum.

Fig. 4-2B illustrates a display using optimum resolution bandwidth which results in an accurate spectrum envelope.

resolution  
bandwidth  
control

Fig. 4-2C and 4-2D illustrate the effect on the display of using a resolution bandwidth greater than one-tenth of the minor lobe null frequency difference. The excessive resolution bandwidth tends to average the amplitude of the RF spectrum so that the nulls become obliterated and the display becomes distorted and meaningless. Optimum spectrum display is achieved when the resolution bandwidth is adjusted to approximately one-tenth of the pulse duration. Tektronix spectrum analyzers' uncalibrated resolution bandwidth control settings are coupled with the dispersion control settings to provide the optimum resolution for most signal analysis applications. Whenever it is necessary to change the resolution bandwidth, for instance when displaying the spectrum of a narrow pulsed RF carrier, the resolution control may be uncoupled and adjusted independently for the best display. In such cases the best display generally occurs with the resolution control adjusted for the widest bandwidth.

## 5

SPECTRUM ANALYZER  
FUNCTIONAL CONSIDERATIONS

The detailed operation of individual spectrum analyzer front panel controls is well explained in the instruction manual describing the instrument. However the settings of front panel controls may be unintentionally adjusted to obtain a distorted or incorrect type of display. The following discussion may help avoid operator confusion.

input  
connector  
relative to  
dial scale

With spectrum analyzers that provide multiple input connectors which relate to different radio-frequency ranges or bands, it is necessary to connect the signal source to the applicable input terminal and to switch the band switch to the desired frequency range. If the dial scale contains overlapping frequency ranges, it is possible to read the frequency on a scale which is not in use. Modern spectrum analyzers relate input terminal connectors to dial ranges by means of mutual color shading or other graphics and alphabetical lettering. Dial scale frequency ranges are also printed on the front panel opposite the appropriate dial scale. The likelihood of reading the frequency from the wrong scale was great with earlier instruments which did not have this method of frequency and dial scale identification. However, due to harmonic conversion of the local oscillator frequency, it is still possible on modern instruments.

scale  
ambiguity  
caution

IF  
attenuators

Since the IF switch attenuator in Tektronix spectrum analyzers is capable of 51 dB of signal attenuation and the variable IF gain control is capable of an additional 50 dB it is quite possible to completely attenuate the signal by having these controls adjusted incorrectly. The danger exists that the operator will assume that he has insufficient input signal amplitude and will increase the signal strength to a power level which will destroy the input mixer diode(s). A generally useful approach for setting the IF attenuator and gain controls is to turn all of the IF attenuator switches off and to increase the IF gain control to the position where noise fluctuations just begin to appear on the horizontal sweep display. From

start at  
low input  
level

that starting point either input signal amplitude or the instrument front-panel controls can be adjusted visually for a satisfactory displayed amplitude.

video  
filter

The purpose of the video filter is to narrow the bandwidth of the detector circuit to eliminate noise or any visible modulation between signals spaced closely in frequency. It also is useful to display the envelope of RF pulsed spectra which have high pulse repetition rates. Since the video filter basically integrates or averages the signal level, low pulse repetition rates produce poor results.

operational  
pitfall

If the sweep time were adjusted to eliminate all visible display blinking of a signal being displayed, and the video filter were turned on, the amplitude of the signal would decrease to almost zero. This could influence the operator to increase the incoming signal power in order to recover the signal, thereby overloading and possibly damaging the input mixer.

resolution  
bandwidth

The resolution control is normally coupled to the dispersion control to make it easy to obtain a desirable type of display. However, should the resolution become uncoupled from the dispersion control it is possible to have too narrow a resolution bandwidth for the dispersion in use. Coupled with a "blink free" sweep time this can result in a lack of signal display on the CRT. Once again the operator can mistake this condition for lack of sufficient input power amplitude with the possibility of consequences described earlier.

triggering  
source and  
level

Internal triggering capability is useful in a spectrum analyzer that includes calibrated sweep time in order to measure the pulse period of RF pulses such as transmitted by radars. It is also useful for providing periodic single sweep displays necessary for determining frequency drift rates of oscillators.

External triggering capability can be very useful when attempting to display the frequency spectrum of a signal from an antenna source in the presence of other signals. The sweep of the spectrum analyzer can be synchronized with the transmitted signal by applying a triggering pulse to the analyzer from the nearby transmitter.

- triggering system may be needed
- Although, for most uses a free running or 60-Hz line source repetitive sweep is sufficient, the availability of a sophisticated triggering system expands the measurement capability of a general purpose spectrum analyzer. When the triggered mode of operation is used the trigger level setting and source switch controls have a determining effect on the presence of the display.
- sweep time
- For comfortable viewing it is desirable to operate the sweep time so that the display is continuous without any bothersome "blink" interruption. This is generally possible when displaying signals that do not require the use of the video filter. When the video filter is used in conjunction with a display that requires the narrowest resolution it may be necessary to decrease the sweep time in order to obtain a satisfactory undistorted display.
- intensifier
- The purpose of the intensifier control in the spectrum analyzers in which it is present is to equalize the brightness of the baseline in relation to the vertical signal display. The amount of baseline intensification varies with vertical positioning so that the intensifier control may require readjustment whenever the display is repositioned. If the brightness level as set by the intensity control is high it will predominate and the intensifier control will not affect the display.
- RF center-frequency scale reading
- The foregoing discussion relates to the display of a signal on the face of the CRT. There are other sets of controls which determine the accuracy of the reading of the frequency of the signal as shown on the dial scale. For instance, the dial scale will indicate the frequency of the signal in the center of the graticule within the analyzers specifications if the IF center frequency controls (coarse and fine) are centered within their respective ranges. If these controls are not set to the center of their ranges the dial reading of the center frequency will be offset by an amount equal to the IF center frequency offset.



display  
flatness

If the coarse IF center frequency control is offset from its central position it is possible to adjust the dispersion control for an amount of dispersion which may extend into the roll-off slope response of the IF filter. This will result in a signal display whose amplitude will vary with respect to its horizontal position on the cathode-ray tube. In order for a signal to display a constant amplitude within instrument specifications as it is tuned across the screen of the cathode-ray tube, it is necessary for the IF center frequency controls to be centered within their control range.

RF pulse  
duration  
vs  
sensitivity

It was discussed previously that the resolution bandwidth required to adequately display the envelope of a pulsed RF spectrum was a function of the pulse duration. The resolution bandwidth required was empirically derived and closely approximated by the equation:

$$bw \leq \frac{0.1}{T_d}$$

where

$bw$  = the -3 dB bandwidth of the resolution amplifier

$T_d$  = the RF pulse duration in seconds.

Although this value of bandwidth produces the best visual display it does not produce the maximum spectrum amplitude. The computed resolution bandwidth results in a substantial loss in amplitude. The loss in display amplitude is due to two causes.

1. In using greater than the minimum possible resolution bandwidth (1 kHz in Tektronix microwave spectrum analyzer) a greater bandwidth of noise is amplified. The increased noise degrades the signal-to-noise ratio of the spectrum analyzer by an amount equal to the ratio of the bandwidths. For instance, a resolution bandwidth of 100 kHz would degrade the signal by  $\frac{100 \text{ kHz}}{1 \text{ kHz}} = 100$  times.

A degradation in signal strength of 100 times is equivalent to 20 dB or  $10 \log 100$ .



2. A loss in display amplitude is also incurred because of the decreased energy present in a *pulsed* RF carrier as compared to a CW RF carrier. The loss in amplitude of a pulsed RF spectrum display is dependent upon the duration of the RF pulse and the resolution bandwidth of the spectrum analyzer. The loss in energy has been shown to agree closely with the expression<sup>1</sup>:

$$\text{Loss of sensitivity in dB} = 20 \log \left[ \frac{3}{2} \times bw \times T_d \right]$$

Where  $bw$  = the 3 dB resolution bandwidth  
 $T_d$  = the RF pulse duration in seconds.

The shorter the duration of the RF pulse becomes, the greater becomes the loss in display amplitude. For example a 1- $\mu$ s RF pulse applied to a spectrum analyzer having a maximum resolution bandwidth of 100 kHz would result in a:

$$\begin{aligned} \text{Loss of sensitivity} &= 20 \log \left[ \frac{3}{2} \times 10^5 \times 10^{-6} \right] \\ &= 16.5 \text{ dB} \end{aligned}$$

sensitivity  
criteria

A loss of 16.5 dB in sensitivity may or may not be serious depending upon the basic sensitivity of the analyzer at 100 kHz resolution bandwidth at the operating frequency. An RF pulse width of 0.1  $\mu$ s would result in a display amplitude loss of 36.5 dB which would be serious at almost any operating frequency. Increasing the gain of the IF amplifier to the point of overload will not overcome this loss because the loss occurs due to the narrow bandwidth in the resolution amplifier stages which follow the gain-setting IF amplifier. The only solution to the problem is to increase the bandwidth of the resolution amplifier if it is not already at its maximum bandwidth. Also since the maximum input power is very little affected by pulse width it follows that the maximum useful dynamic range is reduced by the same amount as the loss in sensitivity.

A resolution bandwidth which is narrower than optimum does not degrade the spectrum envelope but merely decreases its display amplitude.

---

<sup>1</sup>MIT Radiation Laboratory Series, Volume 11, Chapter 7

Tektronix specifies spectrum analyzer sensitivity for two resolution control settings for microwave units; 1-kHz resolution is selected as one of the conditions for specifying sensitivity because of the usefulness of this narrow resolution for CW-type signal measurements at minimum dispersion, 100-kHz resolution is the other condition for specifying sensitivity because of the pulsed RF type signal measurements requiring wide resolution bandwidth.

A nomogram of the equation describing the loss in sensitivity for pulsed RF signals related to pulse duration and resolution-amplifier bandwidth is shown in Fig. 5-1.

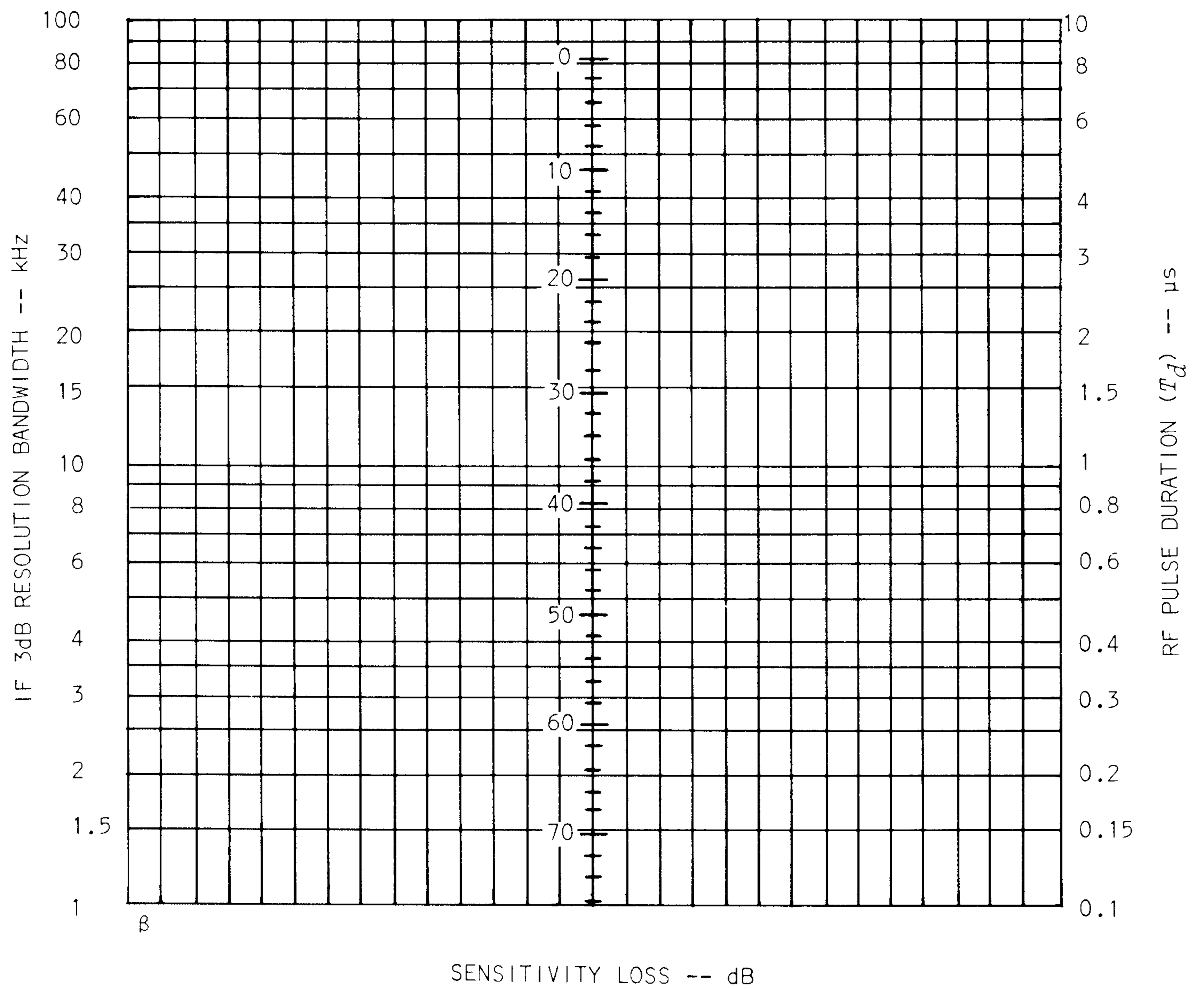


Fig. 5-1. Nomogram of sensitivity loss in the displayed spectrum of an RF pulsed signal.

## 6

## CW SIGNAL MEASUREMENTS

## CENTER FREQUENCY

A CW radio frequency display consists of a single vertical response at the operating frequency. To observe and measure a known frequency, the RF center frequency of the local oscillator must be tuned to the dial reading that gives a direct readout of the incoming frequency with the variable IF center frequency controls centered to midrange and the signal positioned in the center of the graticule scale. If the approximate frequency of the incoming signal is known, the reading may be observed on the appropriate dial scale.

find the  
correct  
scale

When the frequency of the incoming signal is unknown and it is possible to observe a frequency reading on two or more scales it must first be determined on which scale the frequency should be observed. This may be readily determined by positioning the signal with the RF center frequency tuning control from one side of the graticule to the other and comparing the amount of dispersion to a comparable amount of RF center dial frequency change for each of the dial scales. Only *one* of the dial scales will indicate a frequency change equal to the total dispersion. The frequency may then be read off the appropriate scales to within the accuracy specified for the analyzer.

dial  
accuracy

The method which describes the RF center-frequency accuracy in terms of dial frequency is considered to be more informative than describing RF center-frequency accuracy in terms of percentage of the local oscillator frequency. In most cases, the frequency of the LO or the harmonic mixing number cannot be determined without having to refer to the instrument manual.

Both methods specify the identical tolerances but the method used by Tektronix informs the operator directly and quickly, for example:  $\pm(1\% + 2 \text{ MHz})$ .



Fig. 6-1. Conversion chart. Volts-dBm-Watts for 50-ohm impedance.

avoid  
high-level  
signals

In order not to overdrive the input mixer and thereby generate spurious signal responses within the mixer itself, the signal power level should not exceed -30 dBm, if more than one signal is present at the input the sum of all their powers should not exceed -30 dBm. This is equivalent to an input level of 1 microwatt or 7 millivolts applied across an impedance of 50 ohms; Fig. 6-1. Spurious responses appear as frequency components of the signal and are difficult to distinguish from those present due to the signal.

Mixer diodes are subject to severe damage when overdriven by powerful signals. It is therefore strongly recommended that the user be aware of the power levels of the signals about to be applied to a spectrum analyzer. The use of directional couplers, external RF attenuators and even shielded enclosures whichever may be applicable, are recommended whenever it is suspected that the power levels are excessive.

input signal  
attenuation

RF input attenuators may be used external to the spectrum analyzer in series with the incoming signal or they may be integral with the instrument. Two principal advantages arise from using external attenuators:

1. By not being included in the analyzer proper, accessory external attenuators permit a compact instrument design and
2. In the event of serious power overload and subsequent attenuator damage the analyzer is not prevented from being used. The damaged attenuator may be replaced at minimum cost and inconvenience. Repairs do not become a consideration. The disadvantage is primarily one of operator convenience.

stay within  
graticule  
limits

To further minimize the display of spurious responses due to the interaction of external signals within the analyzer, the amplifier gain should be so adjusted that the height of the largest applied signal does not exceed the top of the graticule scale. Displayed signals which exceed the display dynamic range of the analyzer may generate spurious signals which may interfere with the desired signal display, even if the input power is held below - 30 dBm. If the amplitude of all reference signals is attenuated



(IF or RF) to within the graticule scale limits, the undesirable spurious responses will not exceed instrument specifications and display clutter will be minimized. To determine if unexplainable signals are the result or not of overload condition, insert 16 to 20 dB of RF attenuation in series with the applied signal. If overload was the cause, the signals will disappear, otherwise the signals will be attenuated by the amount of attenuation and they will be part of the display.

## FREQUENCY STABILITY

Closely allied to measuring the frequency of a CW signal is the measurement of its frequency stability. Short-term stability concerns fast frequency changes such as those caused by power supply transients and ripple, vibration or other factors associated with the frequency source. Long-term stability concerns the change in frequency as a function of time generally caused by the effect of temperature on the characteristics of some electrical or mechanical components.

The capability of the spectrum analyzer to measure frequency stability is limited only by its own frequency stability, narrow dispersion and resolution bandwidth. Obviously, the oscillators in the spectrum analyzer must be more stable than those whose frequency is to be measured. Tunable local oscillators may be imparted additional stability by synchronization (phaselock) to stable crystal-controlled reference-frequency oscillators. Also, the dispersion must be narrow enough to visually resolve frequency changes on the display. The resolution capability of the analyzer must also be greater than the frequency changes taking place.

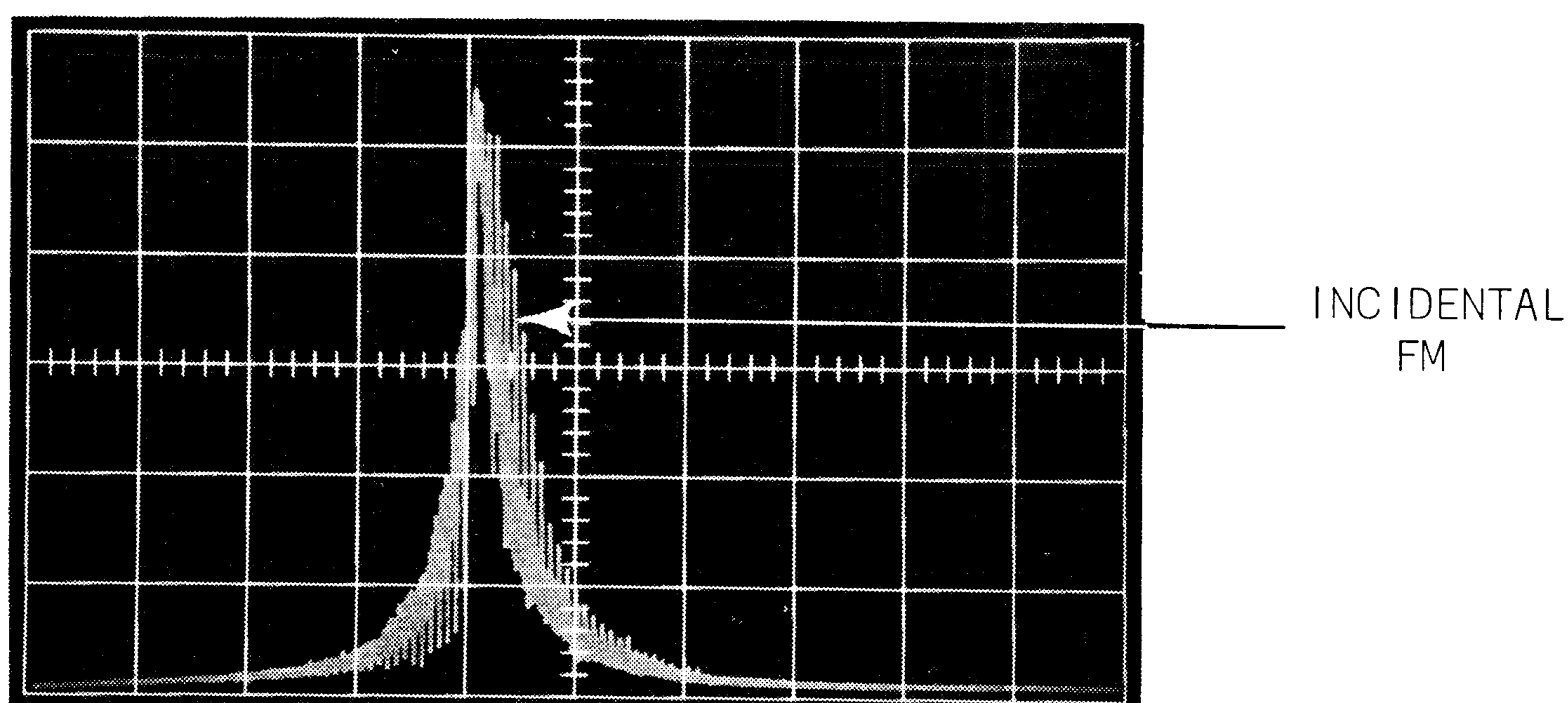


Fig. 6-2. Short term frequency instability less than resolution specification of the spectrum analyzer.

Short-term stability measurements are generally made to indicate the peak-to-peak frequency variation in the signal. A typical display is shown in Fig. 6-2.

#### SHORT-TERM STABILITY MEASUREMENTS

The sweeptime chosen should be one-fifth to one-tenth of the period of frequency change. The width of the vertical slope of the signal waveform represents the short-term frequency instability in the display, which may be measured directly from the display since the dispersion scale is calibrated. For this measurement it is not necessary to have dispersion and resolution better than the magnitude of displayed instability. It should be understood that the instability displayed by the analyzer will be the aggregate of instabilities present in both the analyzer itself as well as that in the signal.

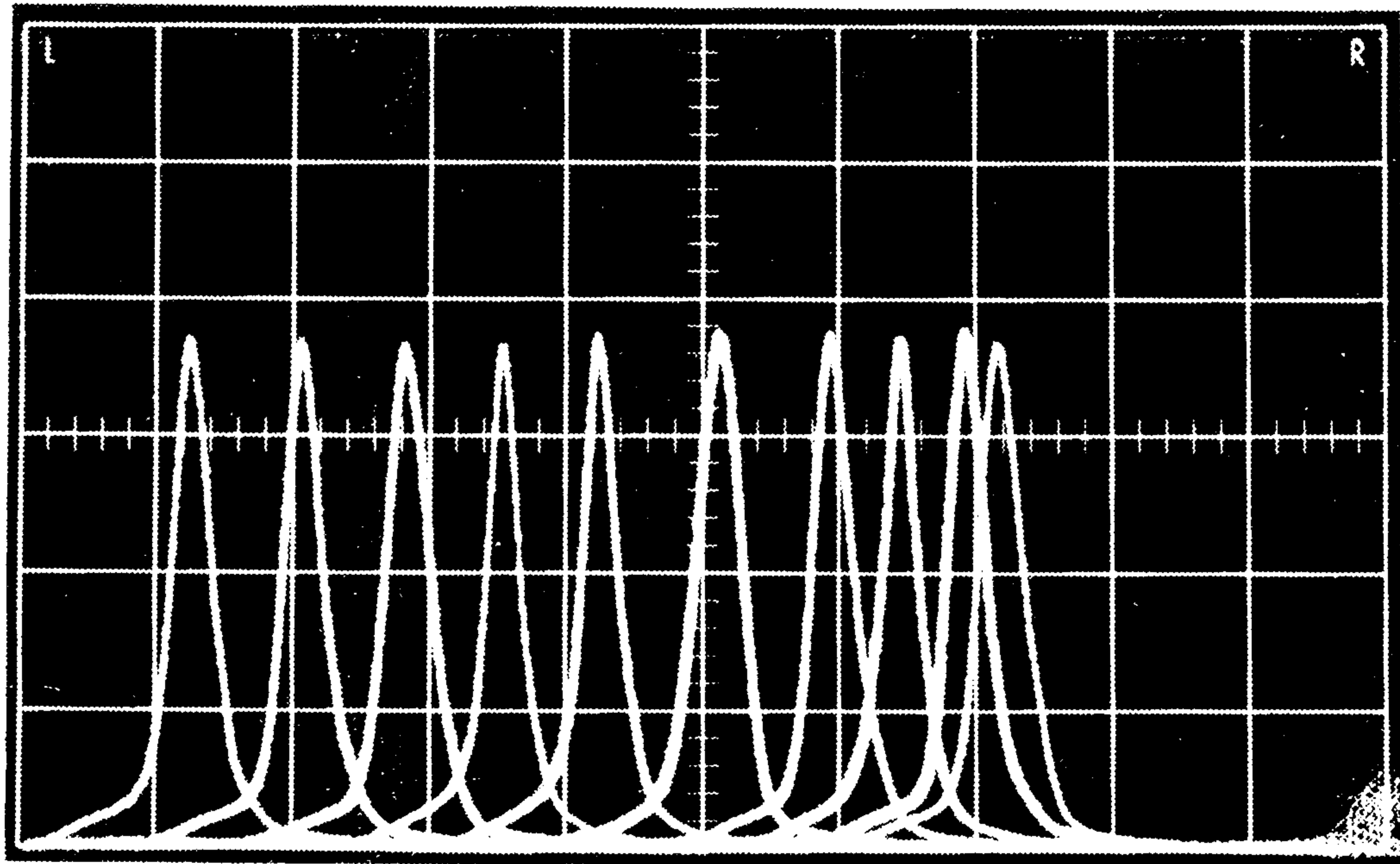


Fig. 6-3. A multiple exposure of long-term frequency instability.

#### LONG-TERM STABILITY MEASUREMENTS

Long-term stability measurements should be made after the analyzer itself has reached temperature equilibrium, so that its drift characteristics are not combined with that of the signal source being measured. Fig. 6-3 illustrates a typical display of a long-term frequency drift measurement obtained by sweeping the spectrum analyzer at periodic intervals. The individual sweeps may be photographed by multiple exposure techniques on film or they may be viewed directly and photographed with a single exposure if the spectrum analyzer has a storage-type cathode-ray tube.

Since the display is taken at constant intervals with calibrated dispersion, information about drift rates, drift in parts-per-million or total drift can be calculated. These measurements indicate the long-term stability of the signal source being measured.

The use of a storage cathode-ray tube in conjunction with a spectrum analyzer is an ideal combination on which to record short or long-term frequency stability measurements.

stability  
specification

The frequency stability specification for microwave spectrum analyzers is quoted for fundamental local oscillator frequency operation. Microwave spectrum analyzers use harmonics of the local oscillator frequency developed in the input mixer to extend their operating frequency range. The frequency stability of the spectrum analyzer is therefore decreased by the harmonic number of the local oscillator frequency used to mix with the incoming signal. That is, if when using fundamental mixing, the LO instability is less than 300 Hz, at the 5th LO harmonic mixing frequency range the instability of the LO harmonic and thus of the spectrum analyzer as a whole will be 5 times the fundamental value or less than 1500 Hz.

## SPECTRAL PURITY

An ideal CW signal would not contain any undesirable adjacent amplitude- or frequency-modulated sideband frequencies. However, due to the presence of power line frequency and its harmonics, mechanical and acoustical vibration, transformer flux leakage, ground currents, thermal, shot and  $1/f$  noise from oscillator semiconductors or other random sources, the purity of the CW signal is decreased. The magnitude of the noise generated by any of the above sources is indicated by the sideband level of modulation accompanying the carrier frequency.

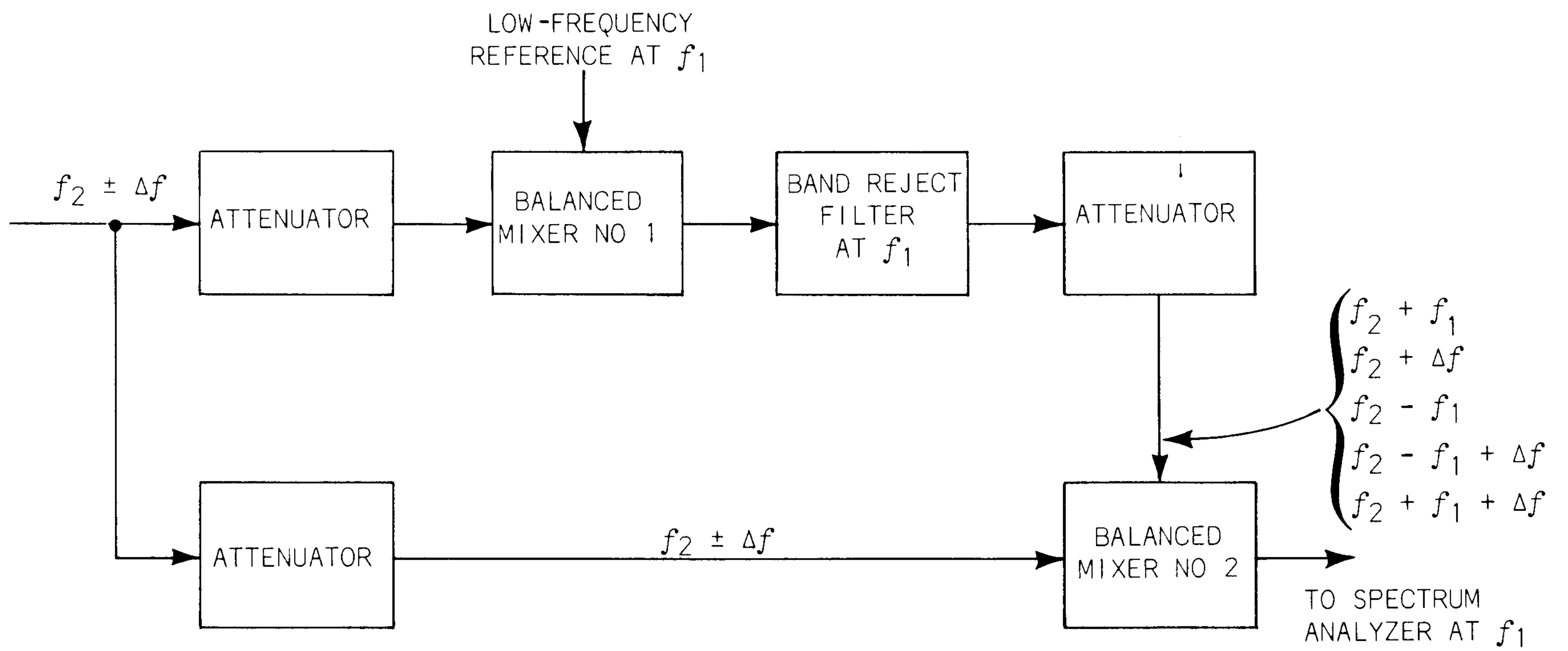


Fig. 6-4. Block diagram of spectral purity measurement.

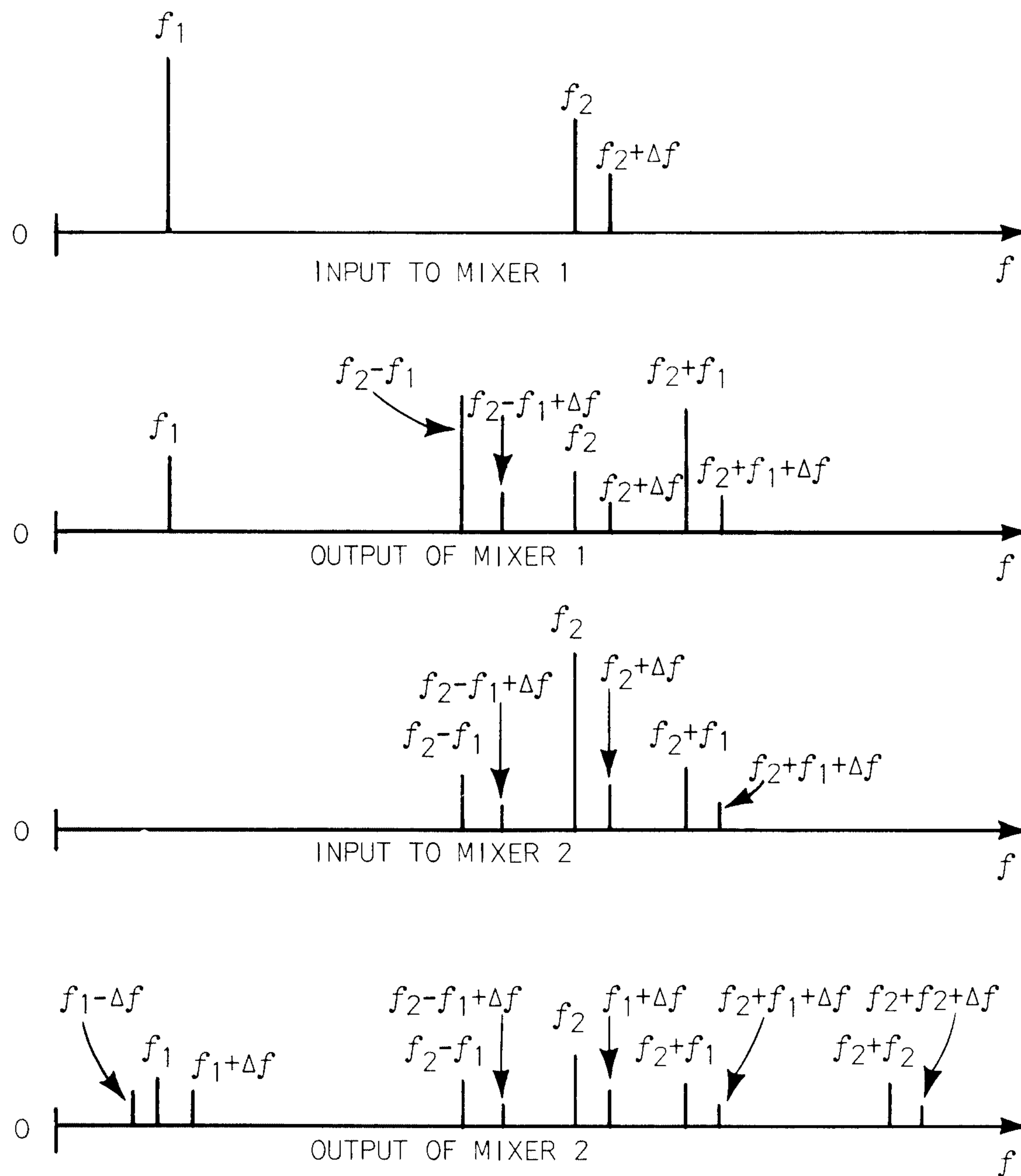


Fig. 6-5. Frequency relationships for the system of Fig. 6-4.



To determine what frequency components may be generated along with the desired signal, a spectrum analyzer having a resolution capability better than the fundamental power-line frequency must be used. RF and microwave spectrum analyzers do not provide such a narrow resolution capability and therefore cannot be used for this measurement. However, a technique is available which can make use of the narrow dispersion and resolution capabilities of low-frequency spectrum analyzers such as the Tektronix Types 1L5 and 3L5. The technique consists in down-converting the desired frequency by means of single or double balanced mixers into the center frequency range of the low-frequency spectrum analyzer Fig. 6-4. This can be accomplished by heterodyning the signal,  $f_2$ , to be measured with a second known stable signal such as a crystal-controlled oscillator,  $f_1$ , to obtain the sum and difference frequencies of the two signals. The low-frequency component,  $f_1$ , is removed from the output of the balanced mixer by means of filters leaving only the sum and difference frequencies of  $f_2 + f_1$  and their combinations which includes any frequency components  $\Delta f$  present adjacent to  $f_2$  (Fig. 6-5). These frequencies are attenuated in order to prevent complex spurious signals from being generated when they are applied to a second balanced mixer and mixed with the original input signal  $f_2 + \Delta f$ . The output of the second mixer, under linear operating conditions<sup>1</sup>, will consist of the frequencies shown in Fig. 6-5. The higher frequency components may be removed with filters and the original low frequency component,  $f_1$  recovered. However,  $f_1$  will now have imparted to it the same general characteristics  $\pm \Delta f$  as the original input signal  $f_2 \pm \Delta f$ .

By means of the double heterodyne process the random FM characteristics associated with the high frequency RF signal have been eliminated, while AM and other sidebands are imparted to the low-frequency carrier. A low-frequency narrow dispersion and resolution spectrum analyzer can now be used to display the frequency components which degrade the purity of the microwave signal.

---

<sup>1</sup>Kauffman and Engelson, "Frequency Domain Stability Measurements," Microwave Journal, May 1967.

## OSCILLATOR SQUEGGING

Presence of squegging in an oscillator may be displayed conveniently on a spectrum analyzer by displaying the oscillator frequency as it is varied over its frequency range. The frequency spectrum generated by the pulsing carrier resembles that of an amplitude-modulated carrier containing sideband components separated in frequency by the squegging frequency and decreasing in amplitude away from the carrier. Fig. 6-6 shows a display of the RF spectrum of a CW variable-frequency oscillator which is squegging.

## HARMONIC FREQUENCIES

measuring  
harmonics

The presence of harmonic frequencies, Fig. 6-7, can be easily detected by increasing the dispersion to encompass the fundamental and as many harmonically related frequencies as possible. The amplitude of the harmonic frequencies relative to that of the fundamental may be measured by inserting either RF or IF calibrated attenuation or a combination of both until the amplitude of the fundamental equals the amplitude reference level of the individual harmonically related frequencies. For example, with the amplitude of the fundamental frequency adjusted to occupy the entire vertical display dynamic range of the spectrum analyzer, it is possible to view harmonic frequencies one hundredth (40 dB) the amplitude of the carrier frequency by the relative comparison method, using the front panel attenuators available on microwave and RF spectrum analyzers.

If the amplitude comparisons are made between two widely separated signals at different positions on the graticule, the display flatness characteristics of the spectrum analyzer may affect the amplitude of each signal differently. Display flatness tolerances will then have to be considered in the accuracy of the measurement.

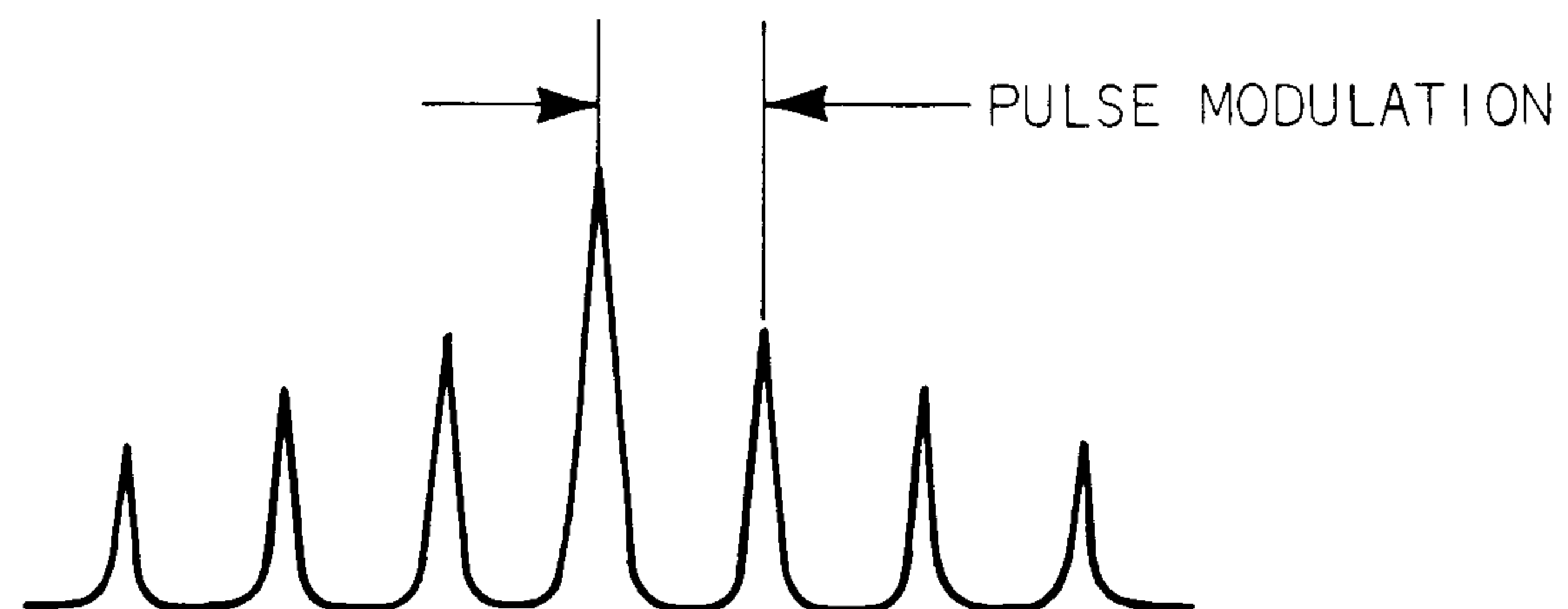


Fig. 6-6. RF spectrum of a squegging CW oscillator at an audio or RF repetition rate.

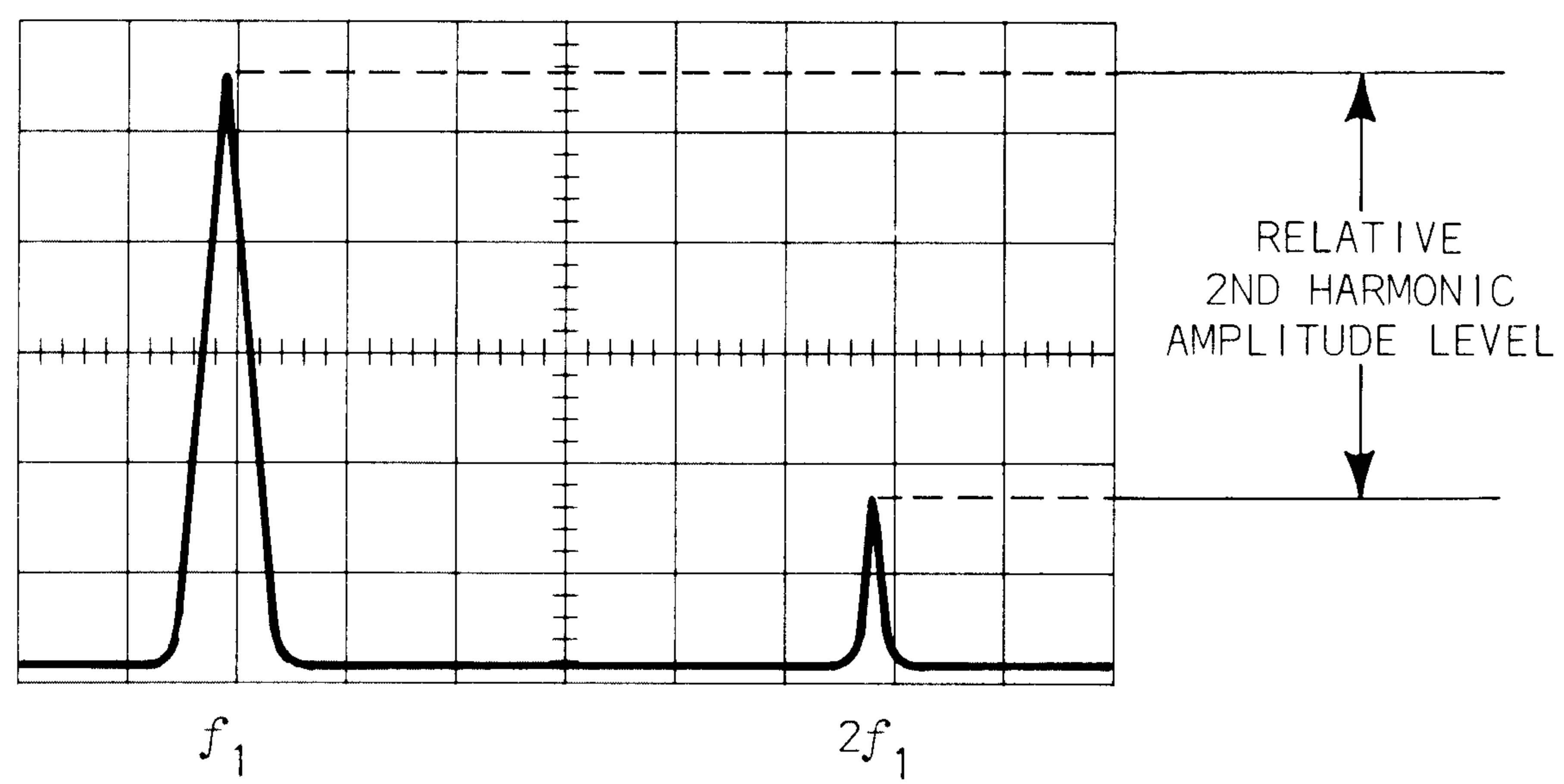


Fig. 6-7. Display shown for relative harmonic measurement.

## SIGNAL COMPARISON MEASUREMENTS

Since the spectrum analyzer incorporates a sensitive tuned receiver as well as a visual signal display it can be used to perform many measurements normally performed by RF voltmeters and RF wavemeters. These measurements can be relative or absolute.

For relative signal measurements the signal deflection from the output of a device under test is compared to the signal deflection obtained at the input of the device, Fig. 6-8. The amount of attenuation inserted in series with the signal display to attenuate the larger of the two deflections to that of the smaller indicates the amount of signal gain or loss associated with the test device. The attenuators available on the front panel of the spectrum analyzer are included to make relative signal comparisons convenient and accurate.

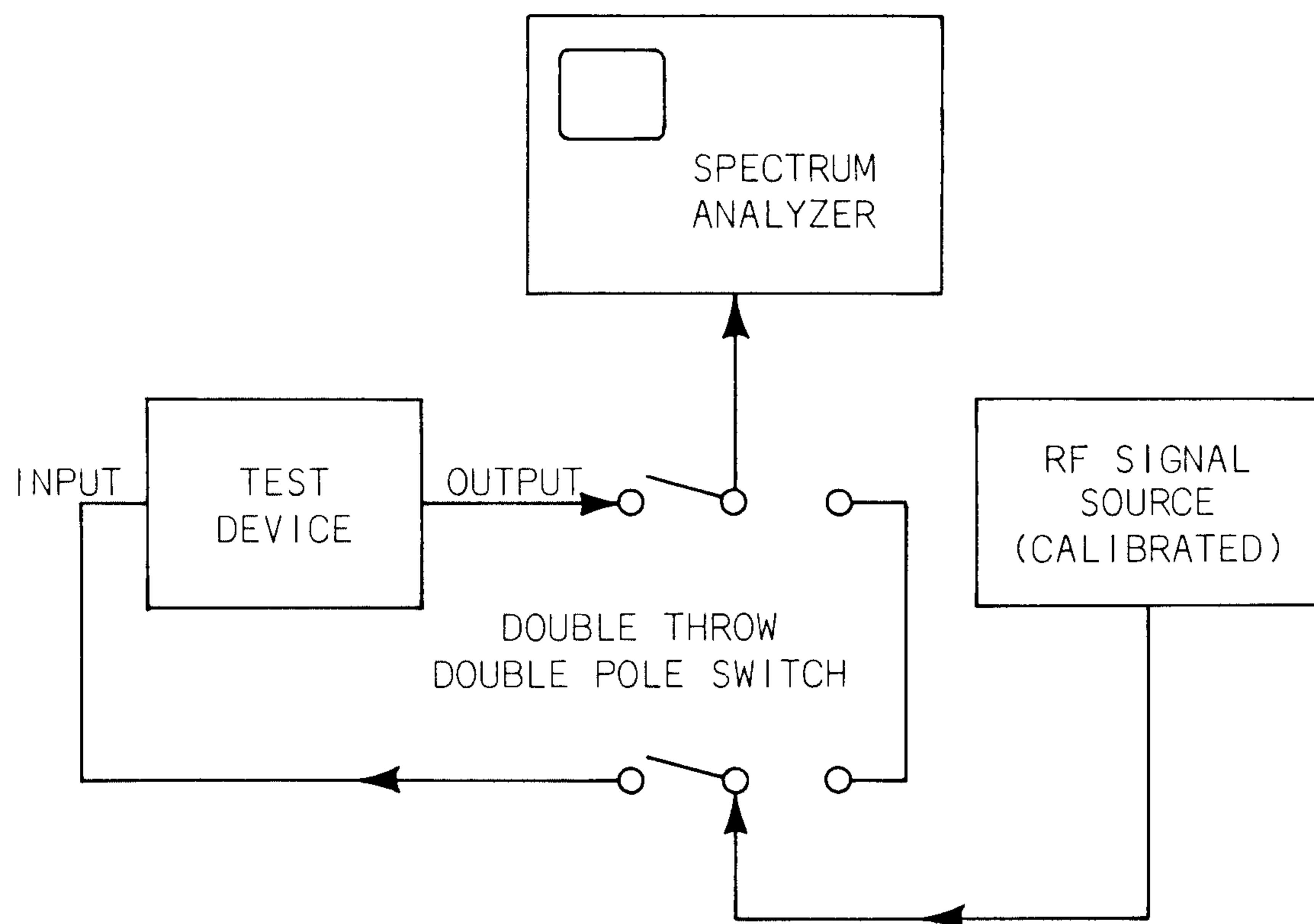


Fig. 6-8. Method of performing signal comparison measurements.

absolute  
signal  
measurements

For absolute signal measurements the signal deflection from the output of a test device is compared to the signal deflection obtained from a calibrated signal source applied to the input of the test device. The amount of attenuation inserted in series with the signal display to attenuate the large to the smaller deflections can then be used to calculate the gain or loss of the output signal in absolute values. The only difference between relative and absolute measurements lies in the use of a calibrated, rather than an uncalibrated RF signal source.

### MIXER CONVERSION LOSS OR GAIN MEASUREMENT

conversion  
loss

It is often necessary to convert a signal from one frequency to another without changing the characteristics of the signal. Frequency conversion is performed by combining or mixing an input signal with that of a local oscillator in a nonlinear device. The desired output signal is extracted from the mixer through the use of frequency-selective filters. The output signal will contain all of the original signal characteristics converted to the desired operating frequency, but at a lower power level. In the mixing process the changing of frequency results in a conversion loss. This loss may be minimized by optimizing the power level of the local oscillator signal applied to the mixer. If too high a power level is used, an increase in noise power will be generated within the mixer. If too low a power level is used, the desired signal amplitude will be degraded. Optimum mixer operation is therefore dependent upon local oscillator power levels.

Conversion loss is defined as the ratio of the amplitude of the signal input power to that of the mixer output power measured at the desired output frequency. It is usually expressed in dB.

conversion  
gain

Microwave mixers which are usually comprised of a silicon point-contact diode do not have the means for amplification and therefore are subject to conversion losses. When mixing is performed at lower frequencies with transistors or other nonlinear operating devices capable of amplifying the converted signal it is possible to obtain a conversion gain instead of a loss. Therefore, depending upon the nonlinear device used, the mixer output signal may indicate a gain or loss relative to the amplitude of the input signal.



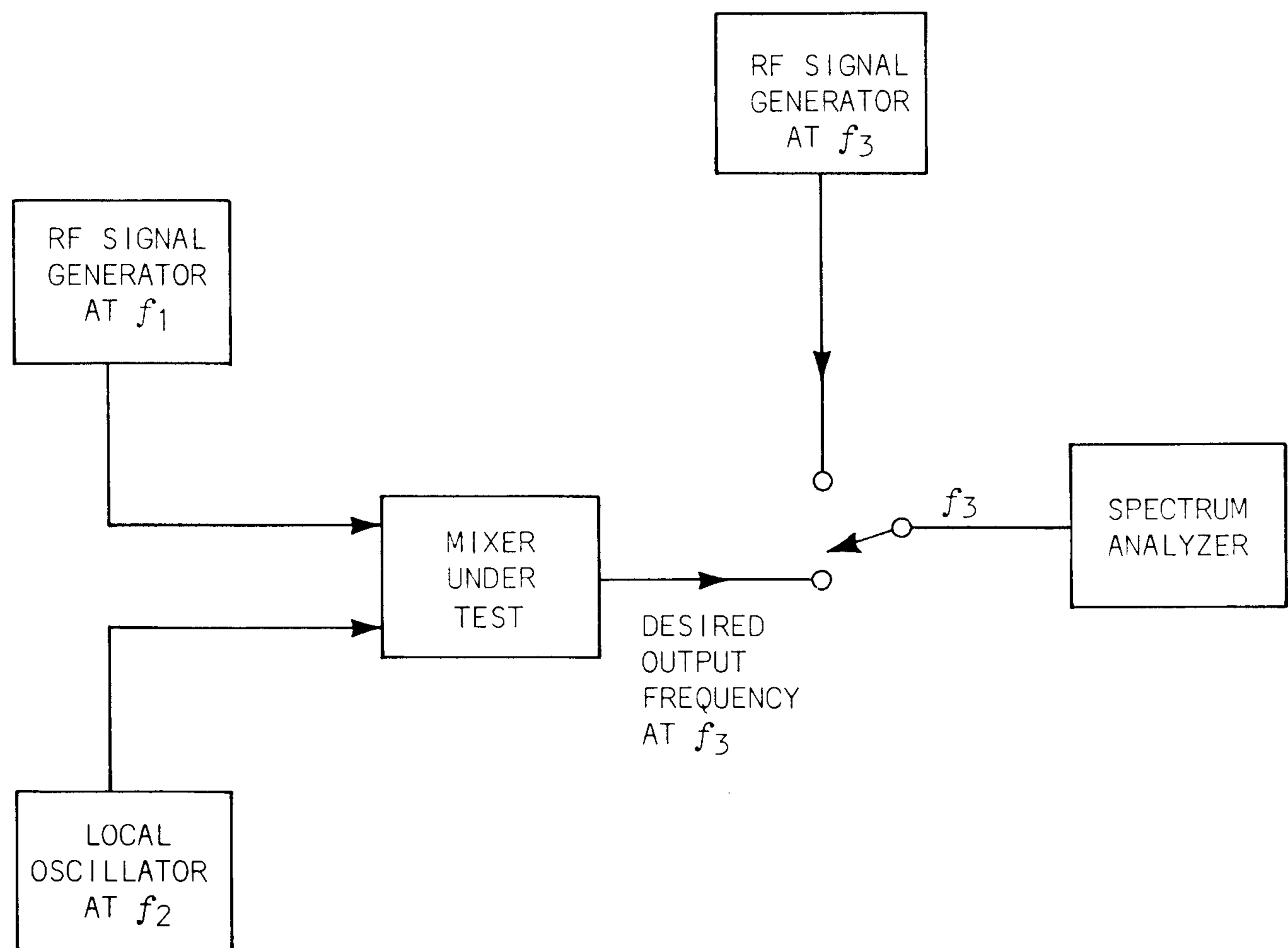


Fig. 6-9. Typical method for conversion loss measurement.

measuring  
conversion  
gain/loss

A spectrum analyzer tuned to the desired output frequency of the mixer can be used as a very effective comparative visual display device. A method of measurement is illustrated in Fig. 6-9. An RF signal generator with calibrated output  $f_1$  and a local oscillator RF generator  $f_2$ , are both connected to the mixer under test. They are set to the proper frequencies which will result in the desired output frequency  $f_3$ , being displayed on the spectrum analyzer. The output power levels of both generators should be adjusted for satisfactory frequency conversion of the RF input signal. The height of the desired signal  $f_3$ , on the spectrum analyzer is noted or recorded. A second RF signal generator with calibrated output is tuned to the desired output signal frequency  $f_3$ , and substituted for the mixer under test.

impedance

The output of the second RF signal generator is adjusted to display the same signal height as that obtained from the mixer under test. By comparing the calibrated outputs of both RF signal generators the conversion loss or gain may be computed in terms of dB. For the comparison to be valid, the output impedance of the mixer under test and the second RF signal generator must be the same.

The RF and IF center frequency, dispersion and resolution controls of the spectrum analyzer should be adjusted to present a satisfactory display of the comparative signals. The phase lock mode of operation is not generally required for this measurement but may be used if desired.

## RADIO FREQUENCY RADIATION MEASUREMENTS

A spectrum analyzer may be used as a sensitive RF voltmeter to detect the level of signal radiation from electronic equipment. In this measurement the spectrum analyzer performs the function of a sensitive receiver tuned to the operating frequency of the equipment under test. A calibrated test antenna of 50 ohms output impedance is placed at a specified distance from the equipment under test. The equipment under test is then positioned so that all possible points of RF leakage may be directed toward the antenna. Any RF radiation displayed on the spectrum analyzer may be compared in amplitude to that from a calibrated signal generator by noting the level of the calibrated output signal, Fig. 6-10.

field  
strength

A similar basic procedure will allow the spectrum analyzer to be used as a relative field strength meter. For absolute field intensity measurements the spectrum analyzer screen must be calibrated for signal deflection at the operating frequency by means of an external calibrated signal generator.

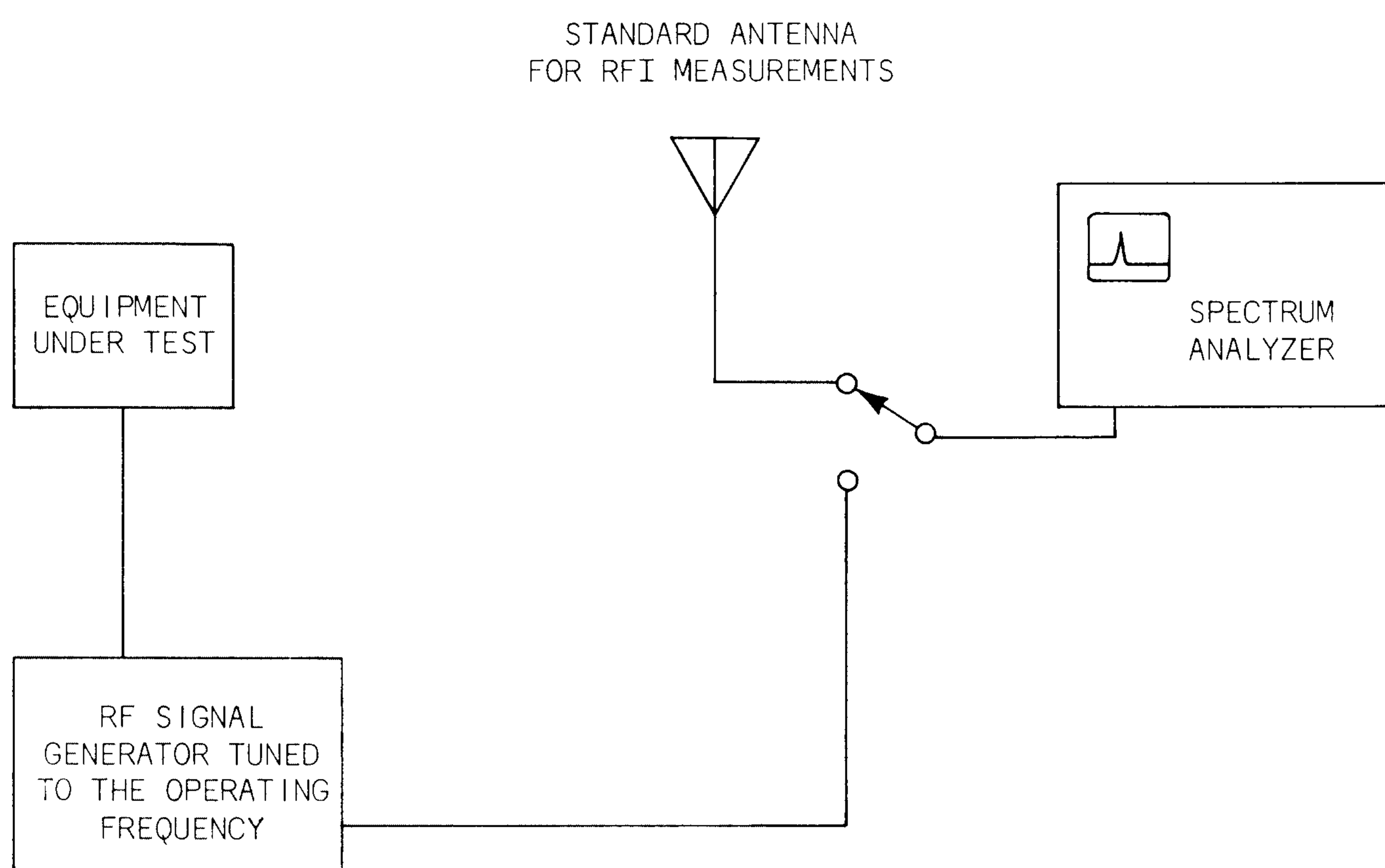
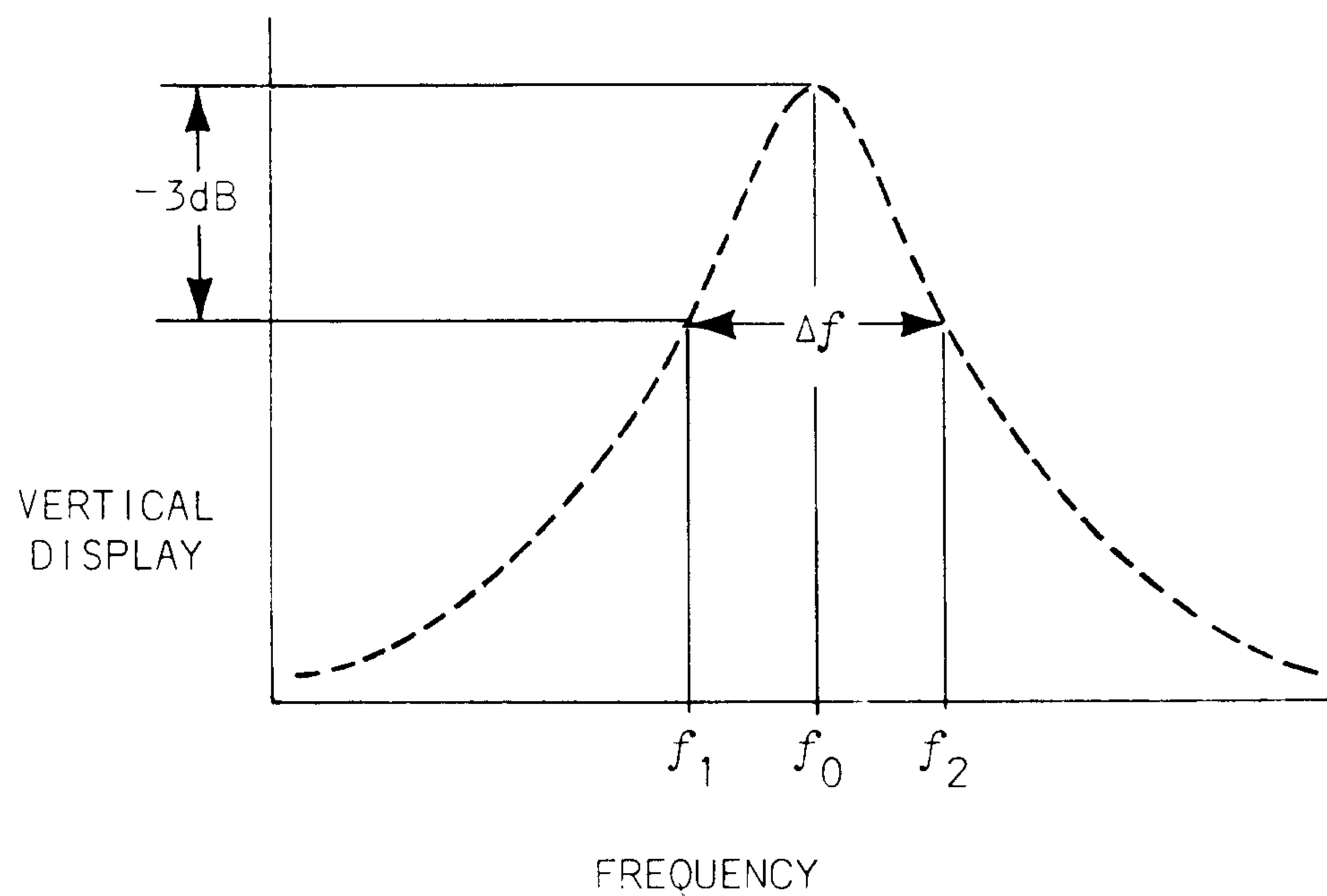


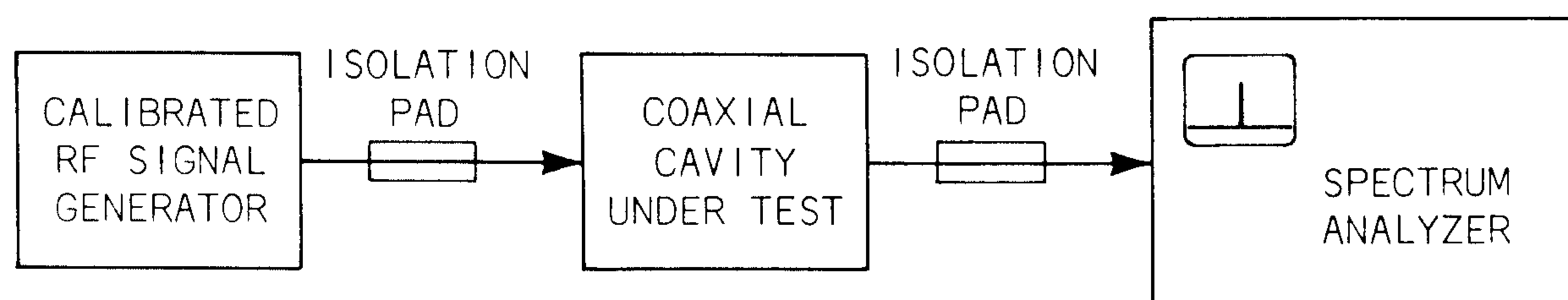
Fig. 6-10. Method of measuring RF radiation from electronic equipment with a spectrum analyzer.

CAVITY RESONATOR Q MEASUREMENT

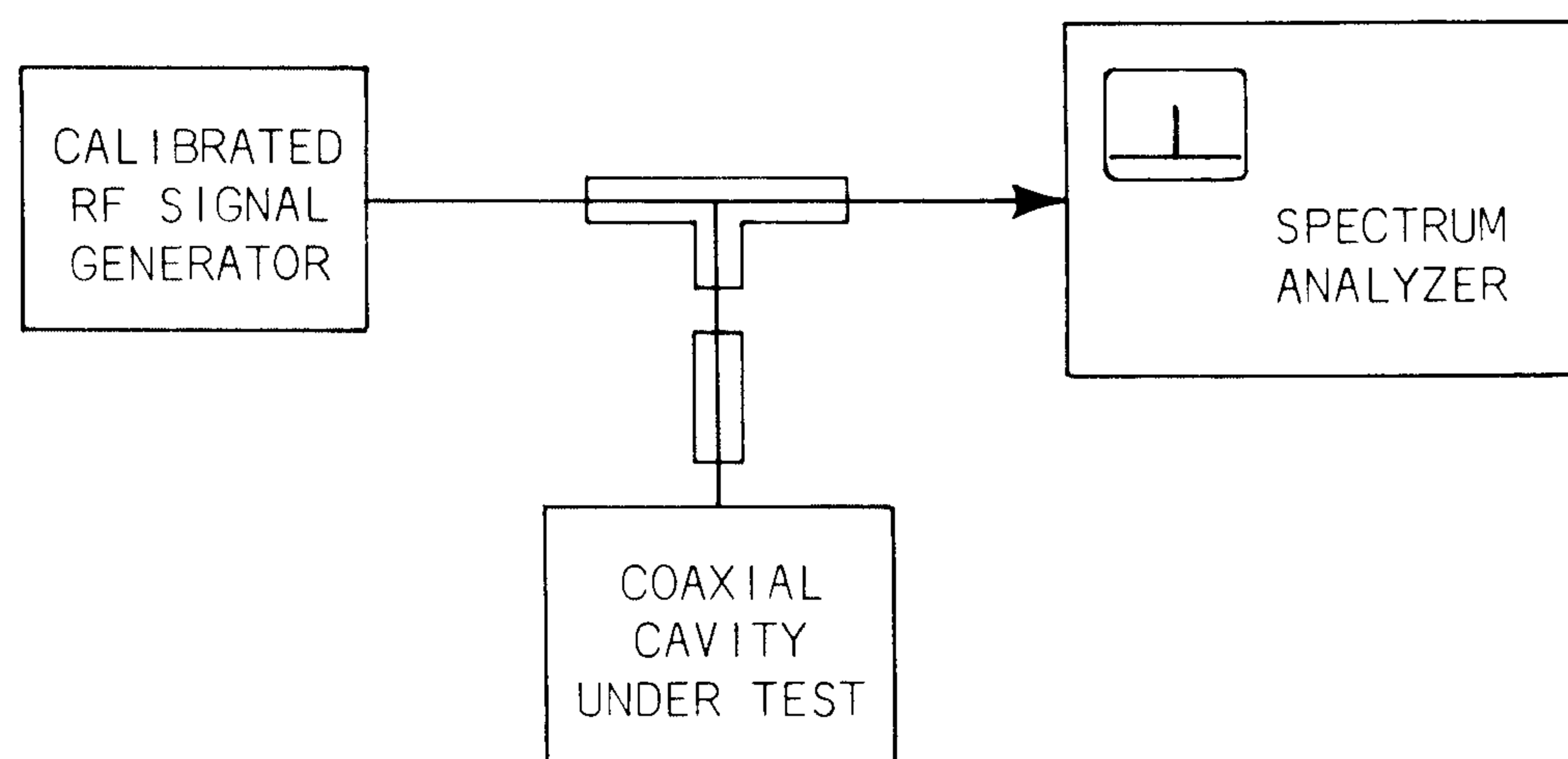
A cavity resonator is the microwave counterpart of a parallel resonant circuit. Cavities are classified as transmission, reaction and absorption types. In the transmission type, maximum energy passes through the cavity only when the frequency of the input signal is equal to the resonant frequency setting of the cavity. The cavity is generally mechanically tunable over a range of frequencies by changing its physical dimensions. The cavity effectively exists as a short circuit except at frequencies near resonance. At these frequencies it exhibits bandpass frequency characteristics as shown in Fig. 6-11.



BROKEN LINES INDICATE LOCUS OF SIGNAL AMPLITUDE AS FREQUENCY IS VARIED THROUGH CAVITY RESONANCE



Q MEASUREMENT METHOD FOR TRANSMISSION-TYPE CAVITIES



Q MEASUREMENT METHOD FOR ABSORPTION-TYPE CAVITIES

Fig. 6-11.

The reaction-type cavity absorbs power from the transmission line at the resonant frequency, however the resonance indication is so slight that other methods to determine its Q must be used. The absorption-type cavity is a single-entry coaxial cavity which exhibits parallel resonant circuit characteristics at its input terminals similar to the transmission type.

cavity  
Q > 1000

The transmission and absorption-type cavities are used in impedance matched transmission systems and are often preceded and followed by impedance isolation devices (pads) whenever a particular system is affected by variations in cavity impedance with frequency tuning. The operating Q of cavities in the frequency range 3 GHz to 10 GHz is typically in excess of 1000.

The transmission cavity generally has a very small input and output coupling so that loading effects (broadening of the frequency response) are negligible. A calibrated RF signal generator may be used as a satisfactory test signal source and a high-sensitivity spectrum analyzer may be used as the signal indicator.

The figure of merit, Q, of the cavity is related to its resonant frequency by the following equation:

$$Q = \frac{f_0}{f_2 - f_1} = \frac{f_0}{\Delta f}$$

where  $f_0$  = resonant frequency of the cavity  
 $f_1$  = half power point of resonant response below resonance  
 $f_2$  = half power point of resonant response above resonance

Half power is equivalent to -3 dB.

The method of determining resonance is to vary the frequency of the calibrated signal generator about the resonance point to obtain the maximum signal deflection on the spectrum analyzer. This frequency represents  $f_0$  in the above equation. The gain of the spectrum analyzer is then adjusted to display a suitable amplitude reference level for the input signal. The signal generator frequency is changed both above and below the resonant frequency to determine frequencies  $f_1$  and  $f_2$  where their amplitudes are exactly 3 dB below the amplitude of

the reference signal. The difference in frequency between  $f_2$  and  $f_1$  is divided into the resonant frequency to compute the Q of the cavity.

Greater accuracy in the computation of Q may be obtained if the value of  $\frac{f_1 + f_2}{2}$  is substituted in

place of  $f_0$  in the above equation. The determination of  $f_0$  may not be as accurate due to the rounding of the resonant response curve at its peak whereas the determination of  $f_1$  and  $f_2$  can be made quite accurately because of the steepness in the slope of the curve at those points.



## 7

## AMPLITUDE-MODULATION MEASUREMENTS

percentage  
amplitude  
modulation  
reference

In amplitude modulation one of the basic reference levels is 100% modulation. This level represents the maximum modulation capability required of a transmitter. 100 percent modulation occurs when the magnitude of the modulating signal is such that the two sideband signals generated on either side of the RF carrier and spaced apart by the modulation frequency are equal in amplitude to one-half the amplitude of the RF carrier in the linear vertical display mode (Fig. 7-1).

signal  
comparison  
measurement

The relative amplitudes of the sideband signals to that of the carrier can easily be determined by the following methods applicable to the type of spectrum analyzer used. In order to avoid complicated discussion of signal analysis, treatment will be limited to modulating signals of single audio frequencies. Spectrum analyzers may include a graticule calibrated in one or more scales equivalent to the vertical display modes of the analyzer so that relative signal amplitude difference in decibels may be observed directly from the graticule. This provides measurement convenience but is limited in

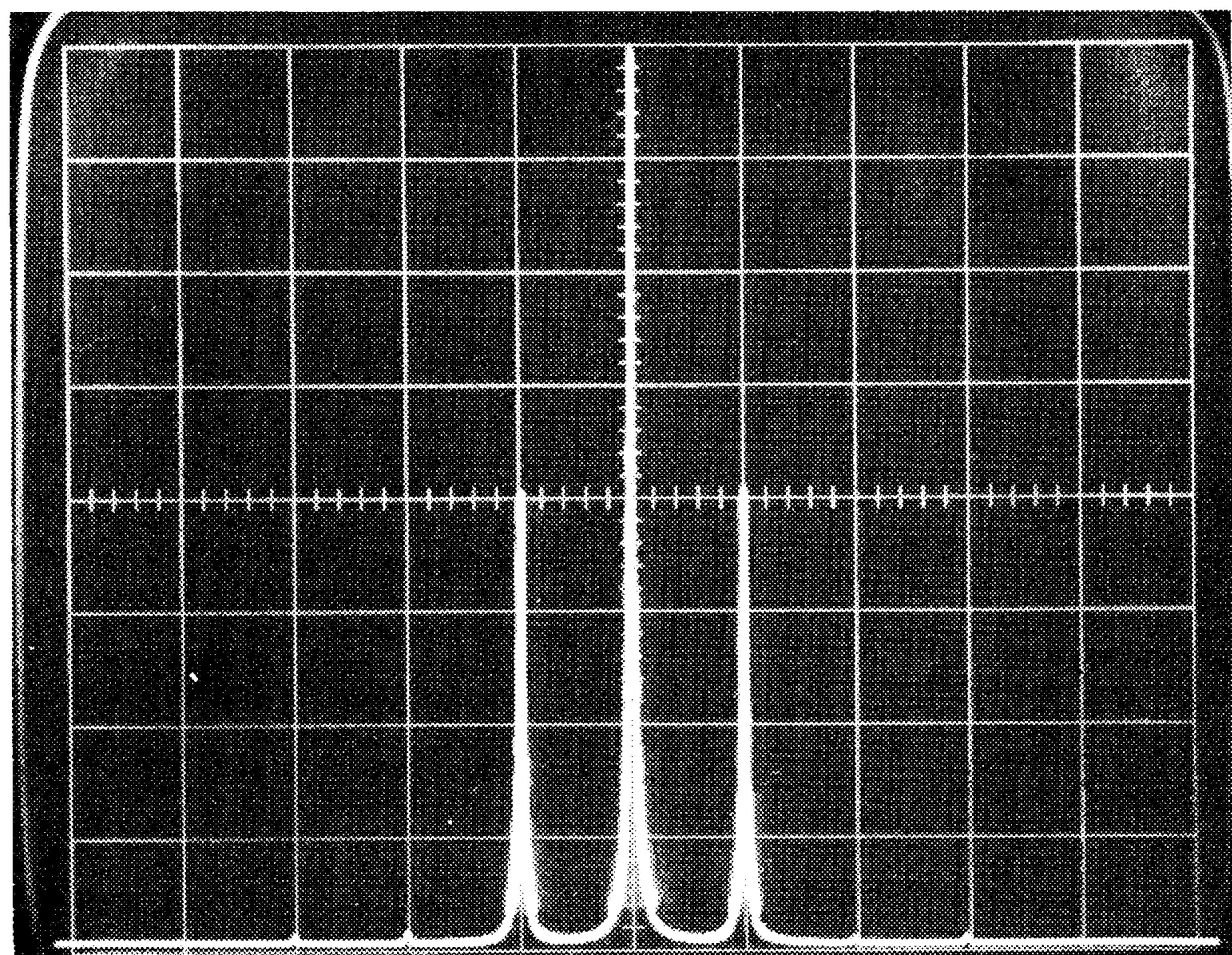


Fig. 7-1. Linear spectrum analyzer display of a 100% AM carrier and sidebands.

accuracy by the observer's ability to resolve small amplitude differences on a logarithmic scale encompassing a wide dynamic range. Spectrum analyzers of the portable or plug-in oscilloscope variety often make use of a front panel attenuator calibrated in one-decibel steps which can be used to compare the amplitude of the carrier to that of the referenced sidebands with an accuracy equal to a tenth of a dB per dB.

The number of dB's of attenuation required to decrease the amplitude of the carrier signal to that of the sidebands may then be expressed in percentage of modulation [dB = 20 log X where X = ratio of sideband to carrier display amplitude]. A dB-to-percentage ratio-conversion table simplifies calculation and provides an accurate conversion from one to the other (Fig. 7-2).

Percentage amplitude modulation of an RF carrier is defined by the expression:

$$\text{Percentage Modulation} = \frac{2 \times \text{amplitude of one sideband}}{\text{amplitude of carrier}} \times 100$$

If the display is calibrated in linear units the above equation may be used directly to determine the percentage of modulation. If the display is calibrated in decibels or the relative amplitude difference between RF carrier and sidebands is determined by a signal attenuator calibrated in decibels, the percentage modulation must be computed. The use of a conversion table such as Fig. 7-2 will help.

The 100-percent amplitude modulation is measured when 6 dB of attenuation is required to attenuate the RF carrier to the level of the reference modulation sidebands. Modulation percentages less than 100% will require attenuation values greater than 6 dB to reach the level of the reference sidebands, since the sidebands will be of lower amplitude and the carrier will have to be attenuated further to reach their reference level. The RF center frequency, dispersion, and resolution controls of the spectrum analyzer must be adjusted to present a suitable display from which measurements can be made. If the tunable local oscillator exhibits frequency instability which prevents accurate

DECIBEL TABLE		
dB OF VOLTAGE OR CURRENT GAIN OR LOSS	RATIO OF INCREASE (TO 1.0)	dB OF POWER GAIN OR LOSS
0	1.0	0
1	1.1	
2	1.3	1
3	1.4	
4	1.6	2
5	1.8	
6	2.0	3
7	2.2	
8	2.5	4
9	2.8	
10	3.2	5
11	3.6	
12	4.0	6
13	4.5	
14	5.0	7
15	5.6	
16	6.3	8
17	7.1	
18	8.0	9
19	9.0	
20	10	10
21	11	
22	13	11
23	14	
24	16	12
25	18	
26	20	13
27	22	
28	25	14
29	28	
30	32	15
31	36	
32	40	16
33	45	
34	50	17
35	56	
36	63	18
37	71	
38	79	19
39	89	
40	100	20
42	130	21
44	160	22
46	200	23
48	250	24
50	320	25
52	400	26
54	500	27
56	630	28
58	790	29
60	1,000	30

Fig. 7-2. Conversion table.

amplitude comparisons from being made, the phase lock mode of operation should be used. This mode of operation will ensure stable operation of the tunable local oscillator so that closely spaced signals, free of incidental FM, may be resolved. The narrower the dispersion and resolution, the slower should be the horizontal sweep rate in order to display signals in their true relationship.

measure  
modulation  
frequency

The modulation frequency can easily be measured, if it is within the resolution capability of the spectrum analyzer, by multiplying the frequency separation between the carrier and sideband signals by the dispersion control calibration setting.

## FREQUENCY-DIVISION MULTIPLEXING TELEMETRY MEASUREMENTS

Standards for frequency-division multiplex of frequency-modulated subcarriers<sup>1</sup> require that the frequency spacing and amplitude level of the subcarriers be adjusted within certain specified limits. Each subcarrier, at a different frequency in the range between 340 Hz to 110 kHz or more, is used to frequency- or phase-modulate an RF transmitter in the RF frequency ranges 216 MHz - 260 MHz, 1435 MHz - 1540 MHz and 2200 MHz - 2300 MHz.

guard  
bands

The selection and grouping of subcarrier channels depend upon the data bandwidth requirements of the application at hand and upon the necessity to ensure adequate guard bands to prevent interference between channels. Combinations of proportional-bandwidth channels (bandwidth proportional to the frequency content of the information being transmitted) and constant-bandwidth channels may be used.

Because each subcarrier is locally frequency modulated with data in the low frequency range, the subcarrier must modulate an RF carrier in order to be transmitted from one point to another. The mode used for this second modulation is also FM or PM. This describes the telemetry system used as FM/FM or FM/PM.

bandwidth

Proportional-bandwidth channels are allocated a bandwidth of  $\pm 7.5\%$  of the carrier frequency. Constant-bandwidth channels are allocated a bandwidth of  $\pm 15\%$  of the carrier frequency.

---

<sup>1</sup>Telemetry Standards Document 106-65.



channel  
spacing

Proportional-bandwidth center-frequency channels are spaced apart in frequency by a ratio of approximately 1.33. This ratio indicates a closeness in frequency separation between subcarriers at the low end of the subcarrier frequency spectrum and a progressively greater spacing in frequency between subcarriers toward the high end of the subcarrier frequency spectrum. When the entire subcarrier frequency range, e.g., 300 Hz to 100 kHz, is displayed on a spectrum analyzer having a linear dispersion, the closeness of the subcarriers at the low-frequency end makes it impossible to display them individually. A spectrum analyzer with a logarithmic dispersion is generally needed. A logarithmic sweep expands the first portion of the sweep and compresses the latter portion so that the subcarriers appear to be evenly spaced across the display. This type of display is very convenient for checking the frequency spacing of subcarriers and for setting their amplitude levels to predetermined values.

logarithmic  
sweep

In the absence of a highly specialized instrument for this particular application a general purpose Tektronix Type 564B Storage Oscilloscope, Type 3B3 Time Base Unit and Type 3L5 50 Hz to 1 MHz Spectrum Analyzer, as shown in Fig. 7-3, can be used to display all of the subcarriers and their relative amplitudes.

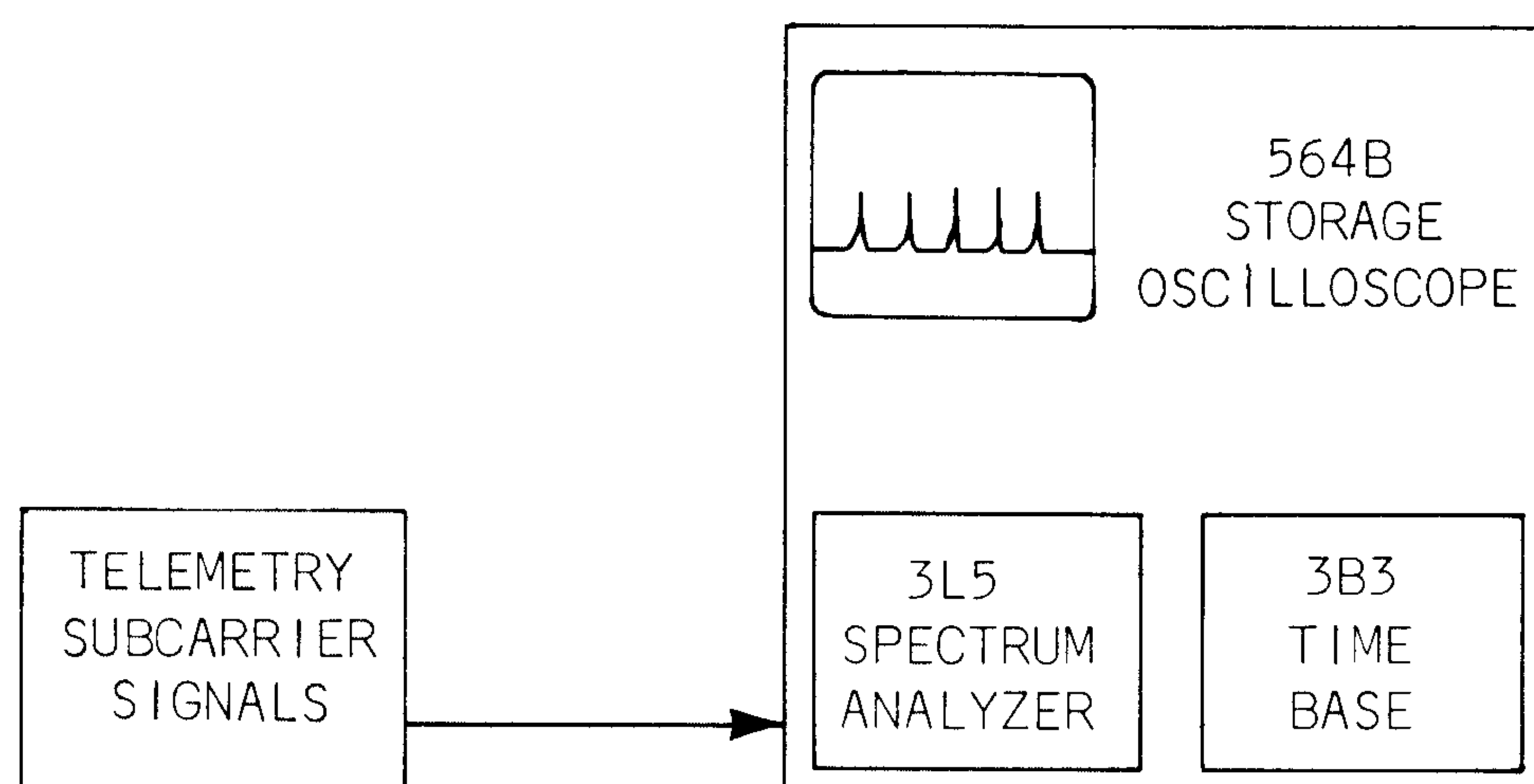


Fig. 7-3. Illustration of method of displaying telemetry subcarriers.



delayed  
sweep

The free-running delayed sweep (DLY'D SWP) mode of the 3B3 provides the capability to display only that part of a normal display shown intensified in brightness. The intensified portion is always displayed across the 10 divisions of the display graticule when the 3B3 mode switch is placed in the DLY'D SWP position. The ratio of the delayed sweep time with respect to the normal sweep time governs how much of the display is intensified. The portion of the display prior to, and after intensification, is not displayed on the screen of the cathode-ray tube.

display  
portions  
of a sweep

With this type of time base operation the ability to display incrementally any portion of a normal sweep is possible. With resolution adequate to display the individual subcarriers, the storage mode of operation will retain the display on the spectrum analyzer as long as necessary to effect an amplitude adjustment.

By continuously turning the variable DELAY TIME control in the intensified mode of operation from its zero setting the intensified portion can be moved across the entire display. If the frequency spectrum of 0 to 100 kHz is displayed in the 3B3 normal mode of operation, the DELAY TIME RANGE control can be adjusted to display as narrow a frequency interval as desired. The 3B3 mode switch can then be placed in the DLY'D SWP position and by rotating the DELAY TIME control, all of the subcarriers can be made to pass across the display. The narrower the resolution the slower the TIME/DIV control settings will have to be.

Proper frequency spacing, spurious signal generation, channel interference and subcarrier amplitude levels can be displayed and measured in this mode of operation.

8

## FREQUENCY MODULATION MEASUREMENTS

Frequency modulation transmitters are allocated specific channel frequencies for operation. These frequencies are spaced throughout the RF spectrum to prevent interference between stations using adjacent channels. It is imperative that each station occupy only its allocated RF spectrum which is defined in terms of center frequency and channel bandwidth.

bandwidth  
limitations

Since the number of significant sidebands of an FM signal increases with the amplitude of the modulating frequency it is necessary to limit the amplitude to prevent sidebands from extending into adjacent channels. It is also desirable to maintain the maximum permissible bandwidth in order to generate the most favorable signal-to-noise ratio throughout the receiving area.

In amplitude modulation, one of the basic reference levels is 100 percent modulation, which represents the maximum modulation capability of a transmitter. With frequency modulation there is no such limitation. However, RF carrier frequency deviation corresponds very closely to percent modulation in AM, but there exists no definite upper limit.

The Federal Communications Commission has assigned commercial FM broadcast station licenses on the basis of 200-kHz channel separation with  $\pm 75$  kHz carrier deviation equivalent to 100 percent modulation. This frequency deviation is sufficient to ensure adequate signal-to-noise reception. An additional  $\pm 25$  kHz is allocated as a guard band to prevent adjacent channel interference.

### FREQUENCY DEVIATION

sidebands

When an RF carrier is frequency modulated by a single sinusoidal voltage, theoretically an infinite number of sidebands, spaced either side of the carrier by multiples of the modulating frequency, are generated. The amplitude of the RF carrier and each

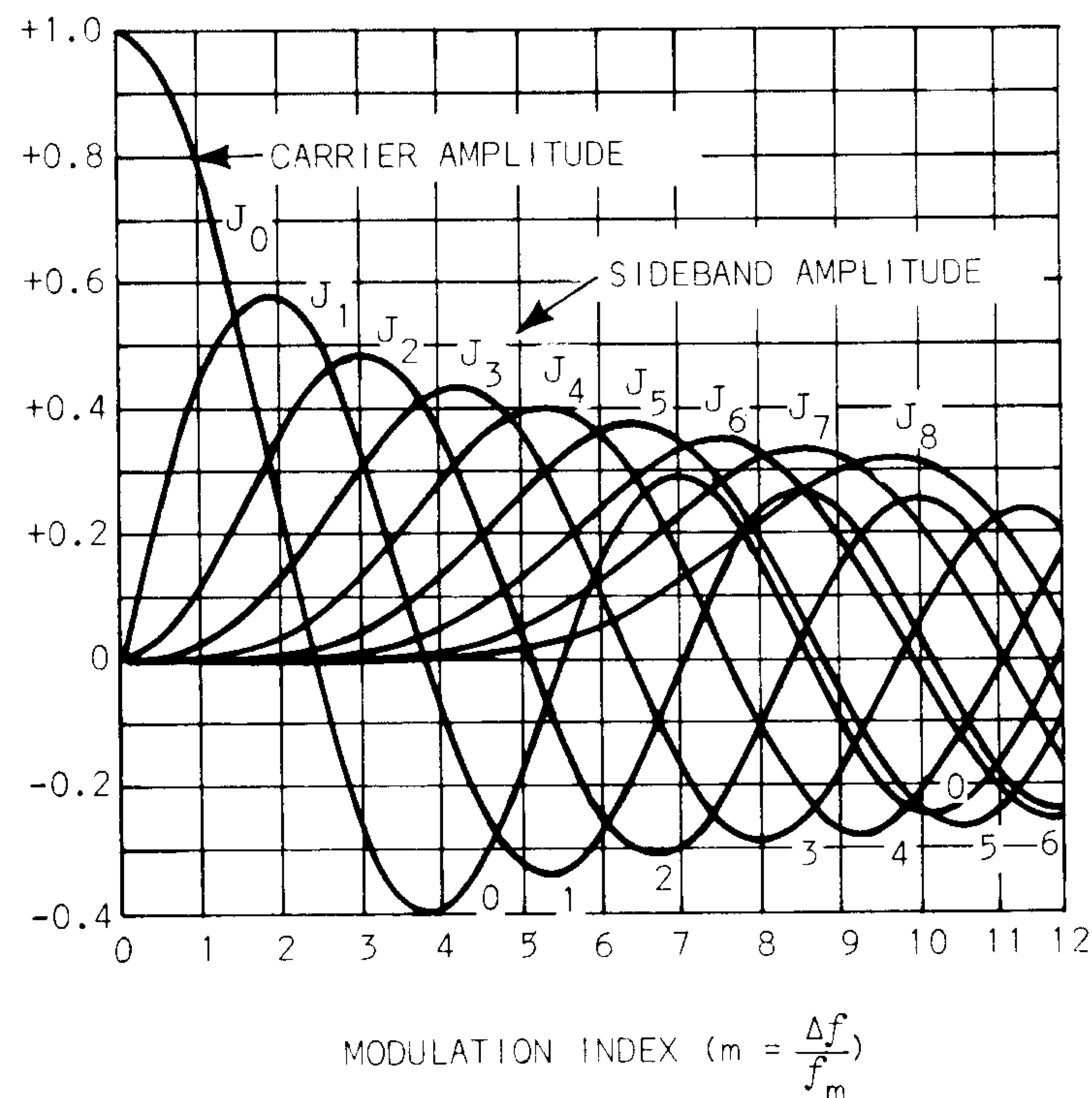


Fig. 8-1. Bessel function values representing relative amplitude and phase of an RF carrier and its FM sidebands.

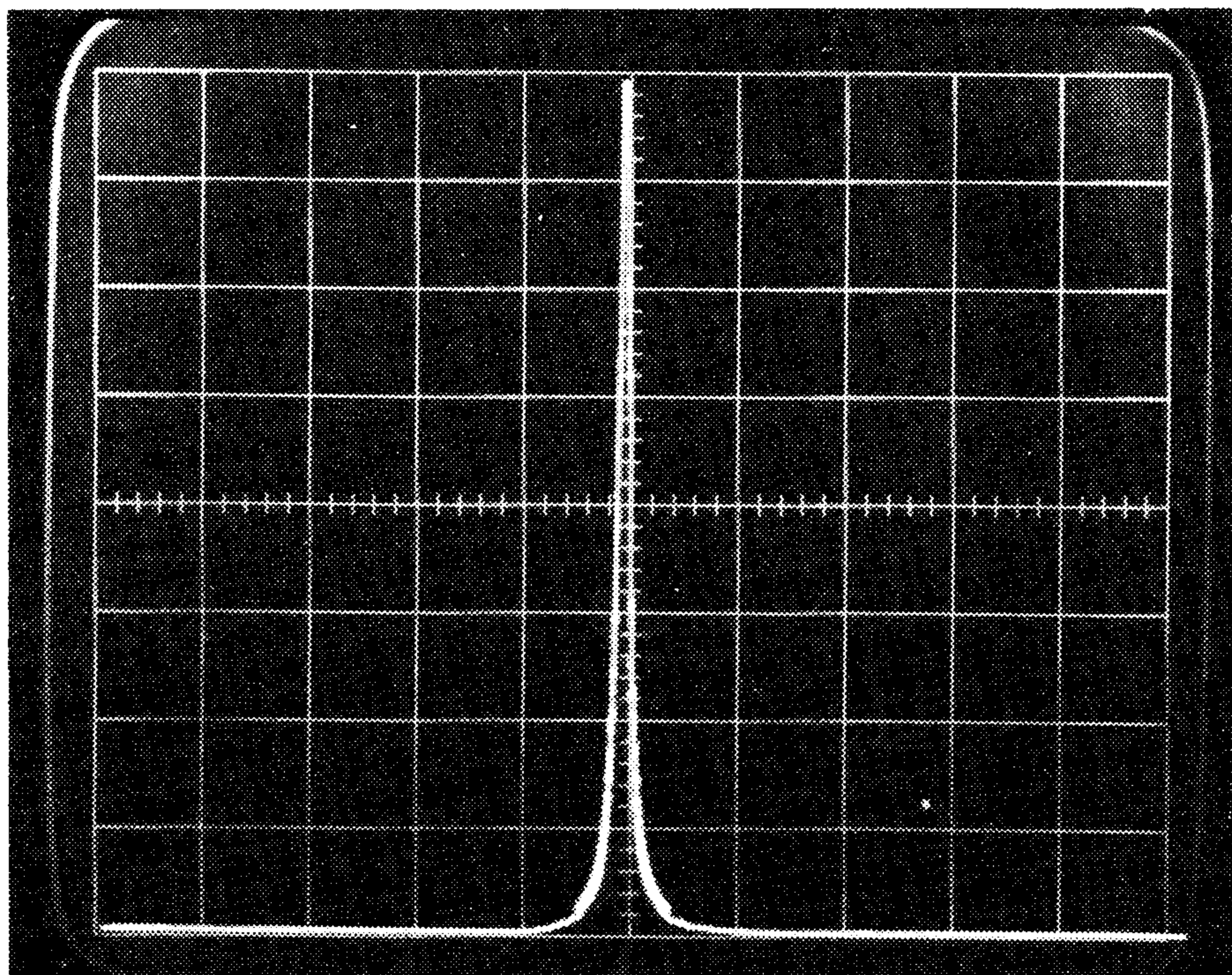
sideband may be expressed mathematically in terms of Bessel functions  $J_0(m)$ ,  $J_1(m)$ ,  $J_2(m)$ , etc. where the subscript refers to the order of the particular sideband<sup>1</sup> and  $m$  represents the modulation index. Fig. 8-1 may be used to determine the amplitude of the FM carrier and sidebands for various values of modulation index. Since a spectrum analyzer cannot distinguish phase, the portions of all the curves below the zero line would be displayed above the line.

From the Bessel function curve  $J_0(m)$ , which describes the amplitude of the carrier for specific values of modulation index, it can be seen that the carrier amplitude decreases to zero at unique values of modulation index.

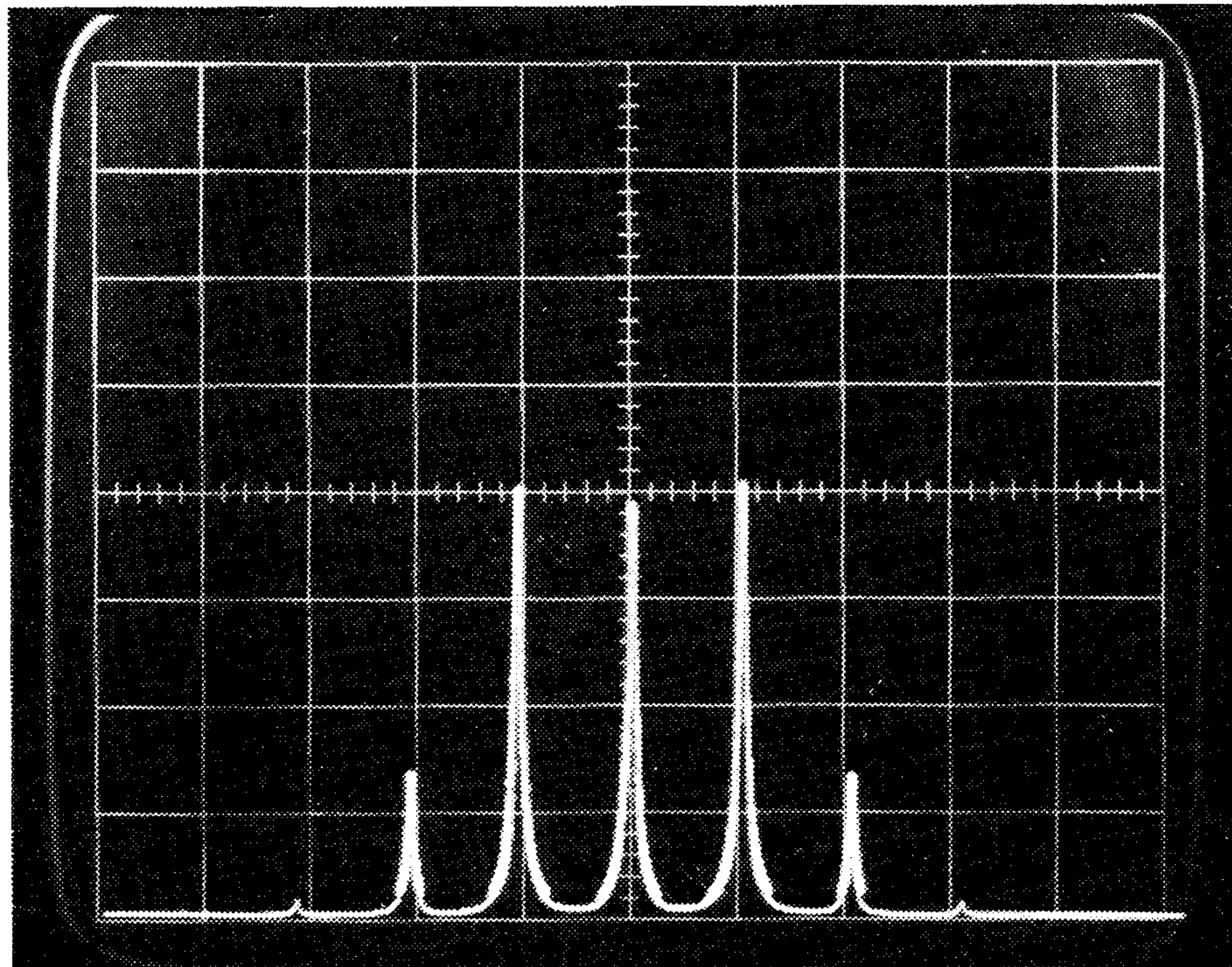
The Crosby Carrier-Null or Bessel-Zero method utilizes the relationship which exists between the frequency deviation  $\Delta f$  and the modulating frequency  $f_m$  when the RF carrier amplitude is nulled to compute the frequency deviation of the carrier. The spectrum analyzer displays carrier level, modulating frequency (spacing between sidebands), number of significant sidebands, and signal bandwidth. The spectrum analyzer is ideally suited to provide all of the information the observer needs to know about a frequency-modulated RF signal in the shortest possible time. See Fig. 8-2.

<sup>1</sup>ITT Handbook, 4th Edition, Page 1066

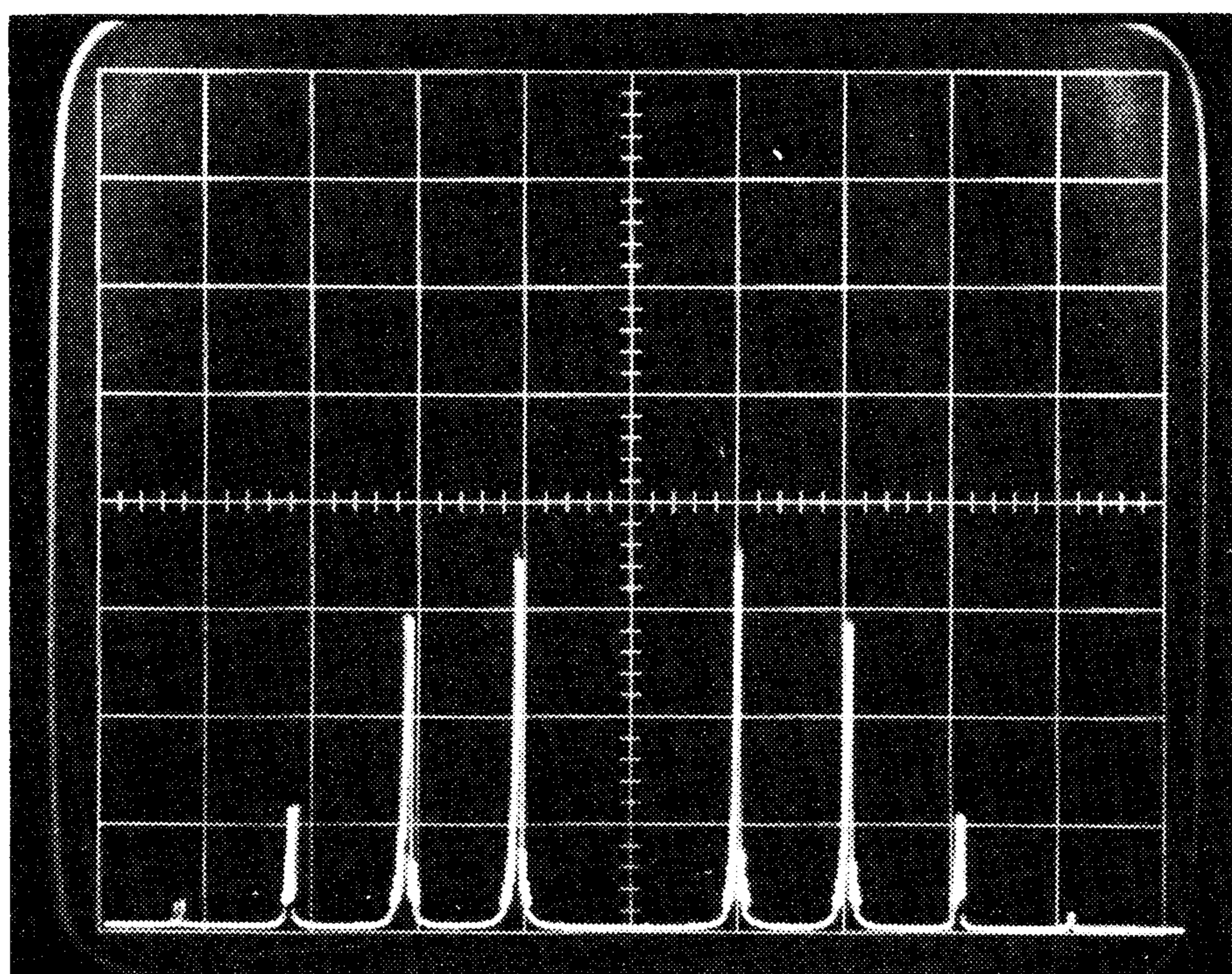




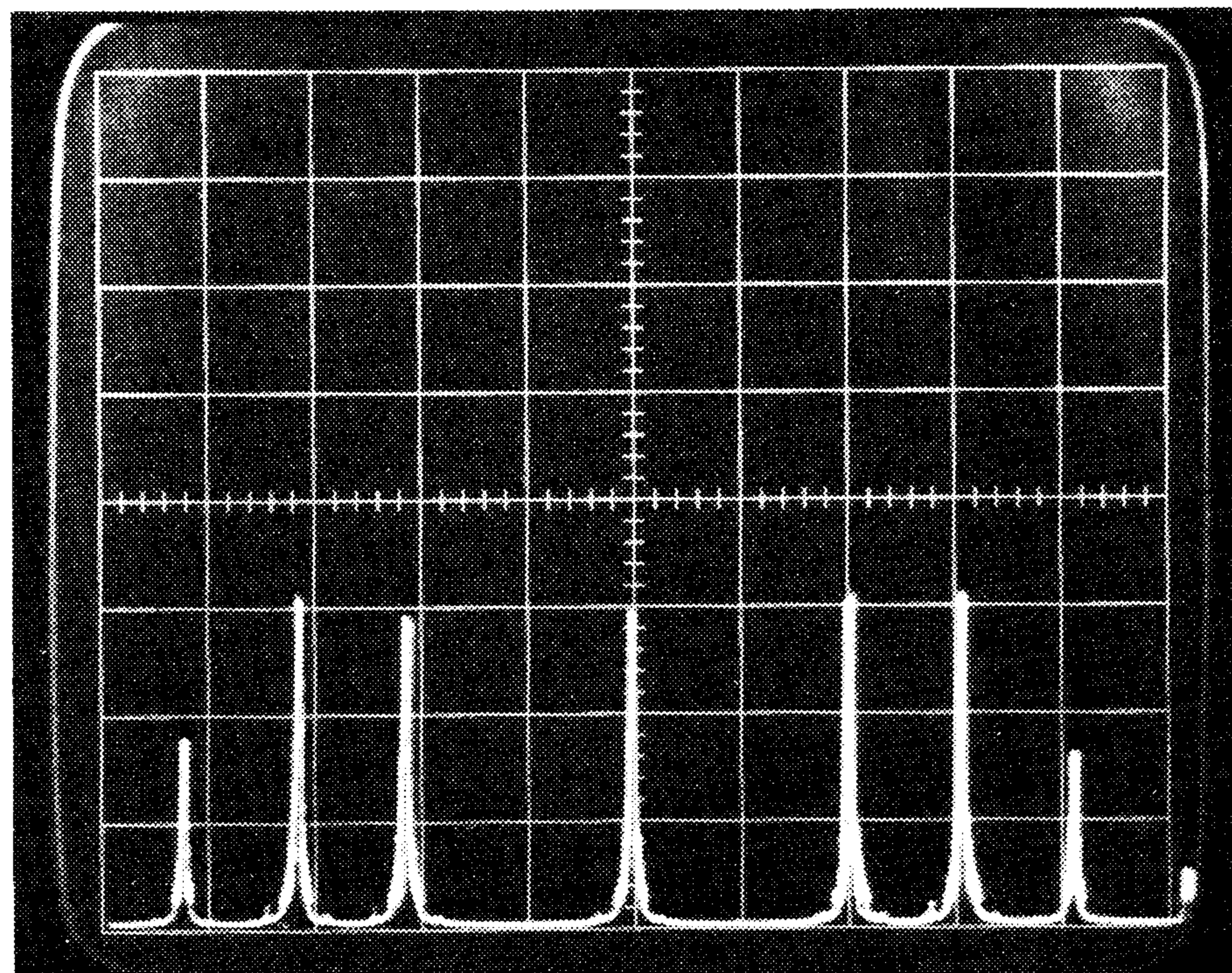
(A) UNMODULATED FM CARRIER AS DISPLAYED ON A TEKTRONIX TYPE 491 SPECTRUM ANALYZER



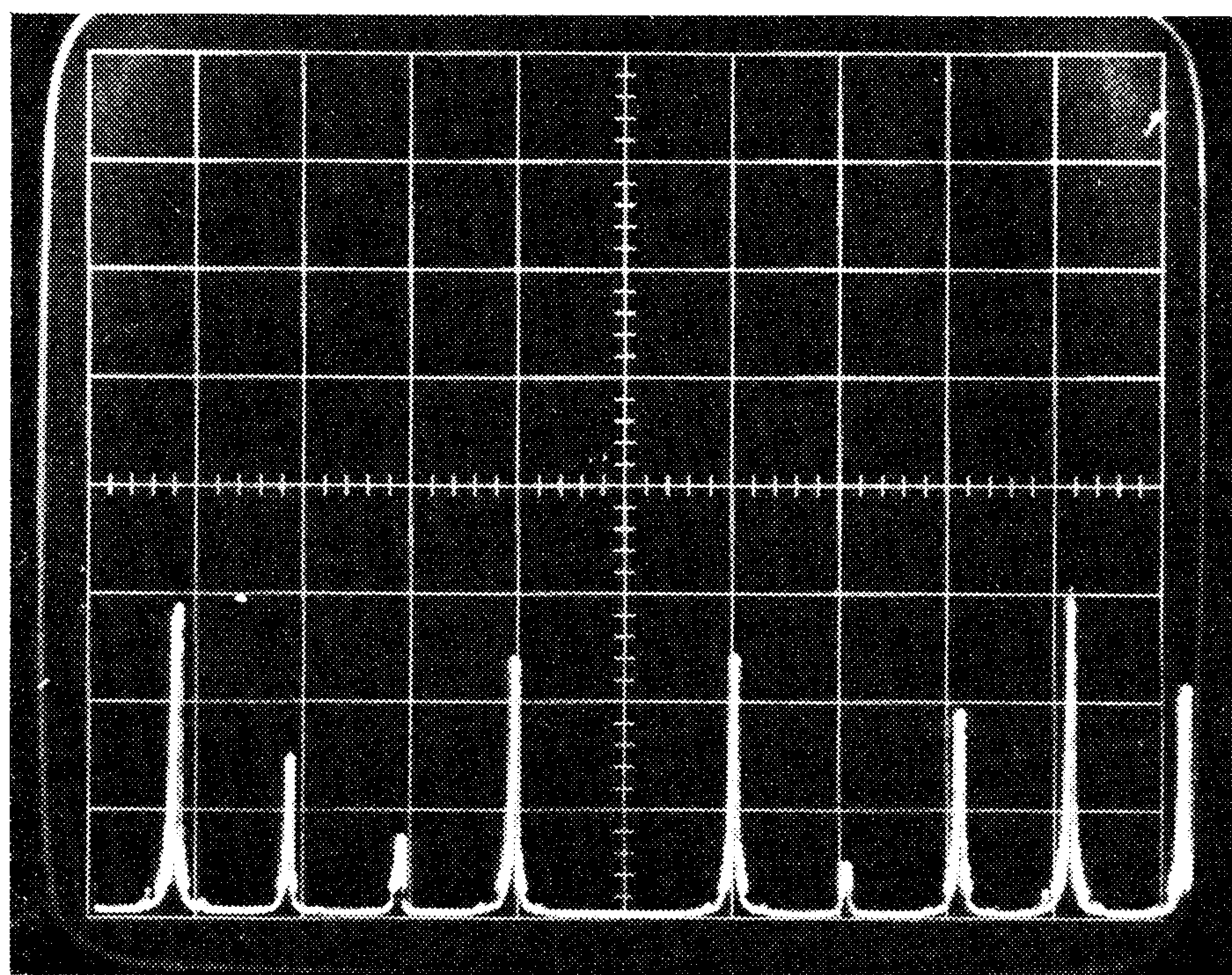
(B) PARTIALLY MODULATED FM CARRIER SHOWING RELATIVE AMPLITUDE OF CARRIER FREQUENCY AND SIDEBANDS



(C) CARRIER FREQUENCY AT FIRST NULL -- MODULATION INDEX OF 2.4, SEE FIG. 8-4



(D) FIRST ORDER SIDEBANDS NULLED AS AMPLITUDE OF MODULATION INDEX IS INCREASED -- MODULATION INDEX APPROXIMATELY 3.8 -- REFER TO FIG. 8-1



(E) CARRIER FREQUENCY SECOND NULL -- MODULATION INDEX OF 5.5 -- SEE FIG. 8.4

Fig. 8-2.

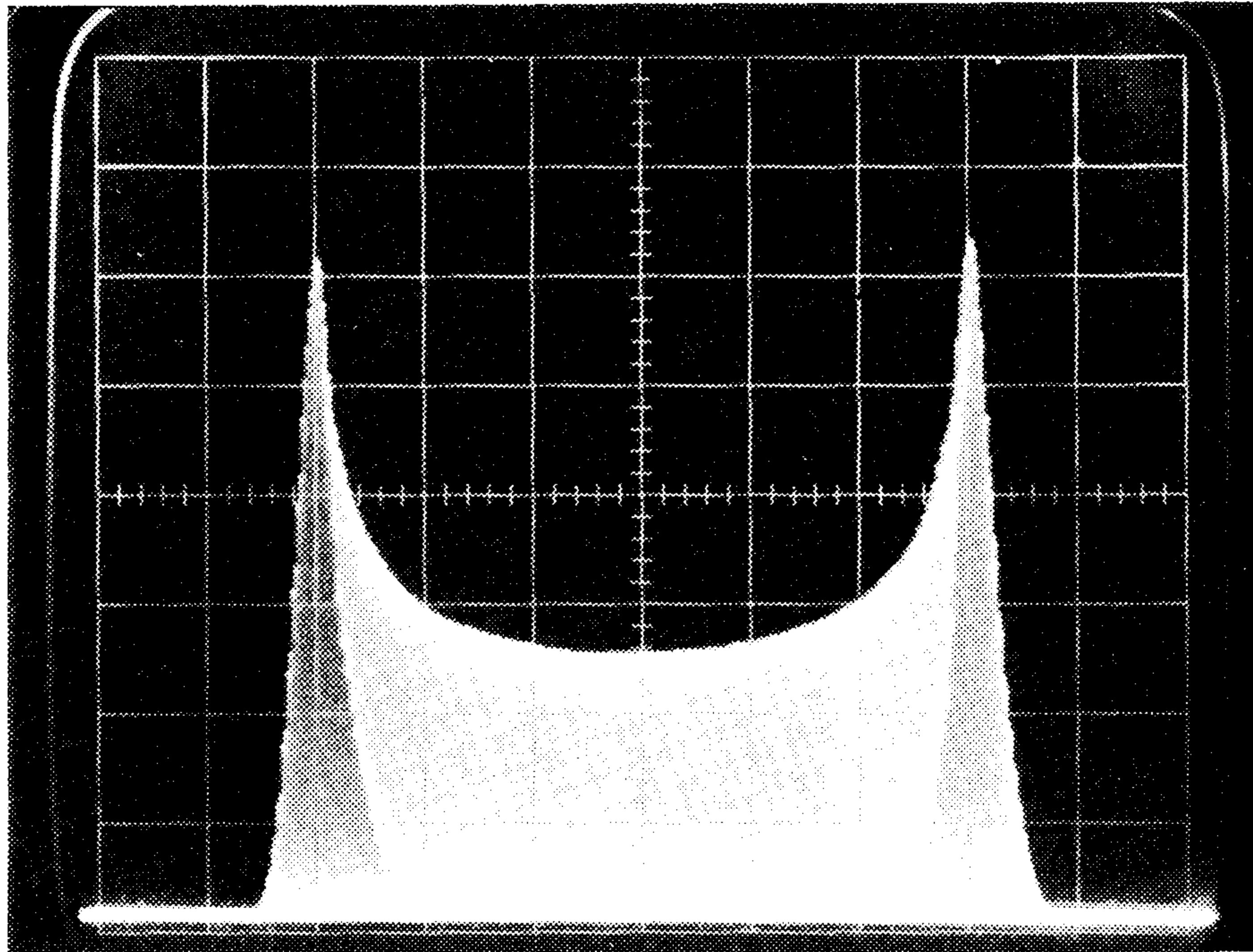


Fig. 8-3. Single-tone frequency modulated signal bandwidth. Spectrum analyzer resolution bandwidth much greater than the modulating frequency.

Fig. 8-3 is a display of the spectrum bandwidth of a sinusoidal frequency-modulated signal with resolution much greater than the modulating frequency. The mathematical relationship between the frequency deviation and the modulating frequency as the amplitude of the modulating frequency is increased continuously from zero is expressed by:

$$m = \frac{\Delta f}{f_m}$$

Where  $m$  = modulation index  
 $\Delta f$  = frequency deviation (1/2 peak-to-peak carrier deviation)  
 $f_m$  = frequency of the modulating signal.

Specific values of modulation index used to determine the frequency deviation are those for which the RF carrier strength is equal to zero amplitude for the particular modulating frequency used (Fig. 8-4) and are listed in Table 8-1.

The frequency of the modulating signal  $f_m$  can be easily obtained from the dial scale of a calibrated audio-frequency signal generator, or read directly as a frequency difference from the scale of a calibrated-dispersion spectrum analyzer. Since it is visually apparent when the RF carrier is at zero level, very accurate determinations of the frequency deviation can be made.



limit the  
input power  
level

At all times the power level to the input of the spectrum analyzer should be below that of the maximum specified input level to obtain linear and satisfactory operation of the instrument. The unmodulated RF carrier should be applied to the input terminals and the RF center-frequency controls adjusted to place the signal in the center of the visual display. The height of the signal should be adjusted to occupy the completed dynamic range of the graticule in the log display mode so that accurate determination of the carrier null may be made.

CARRIER NULL	MODULATION INDEX ( $\frac{\Delta f}{f_m}$ )
FIRST	2.4048
SECOND	5.5201
THIRD	8.6537
FOURTH	11.7915
FIFTH	14.9309
SIXTH	18.0711
SEVENTH	21.2116
EIGHTH	24.3525
NINTH	27.4935
TENTH	30.6346

Table 8-1. Modulation index values.

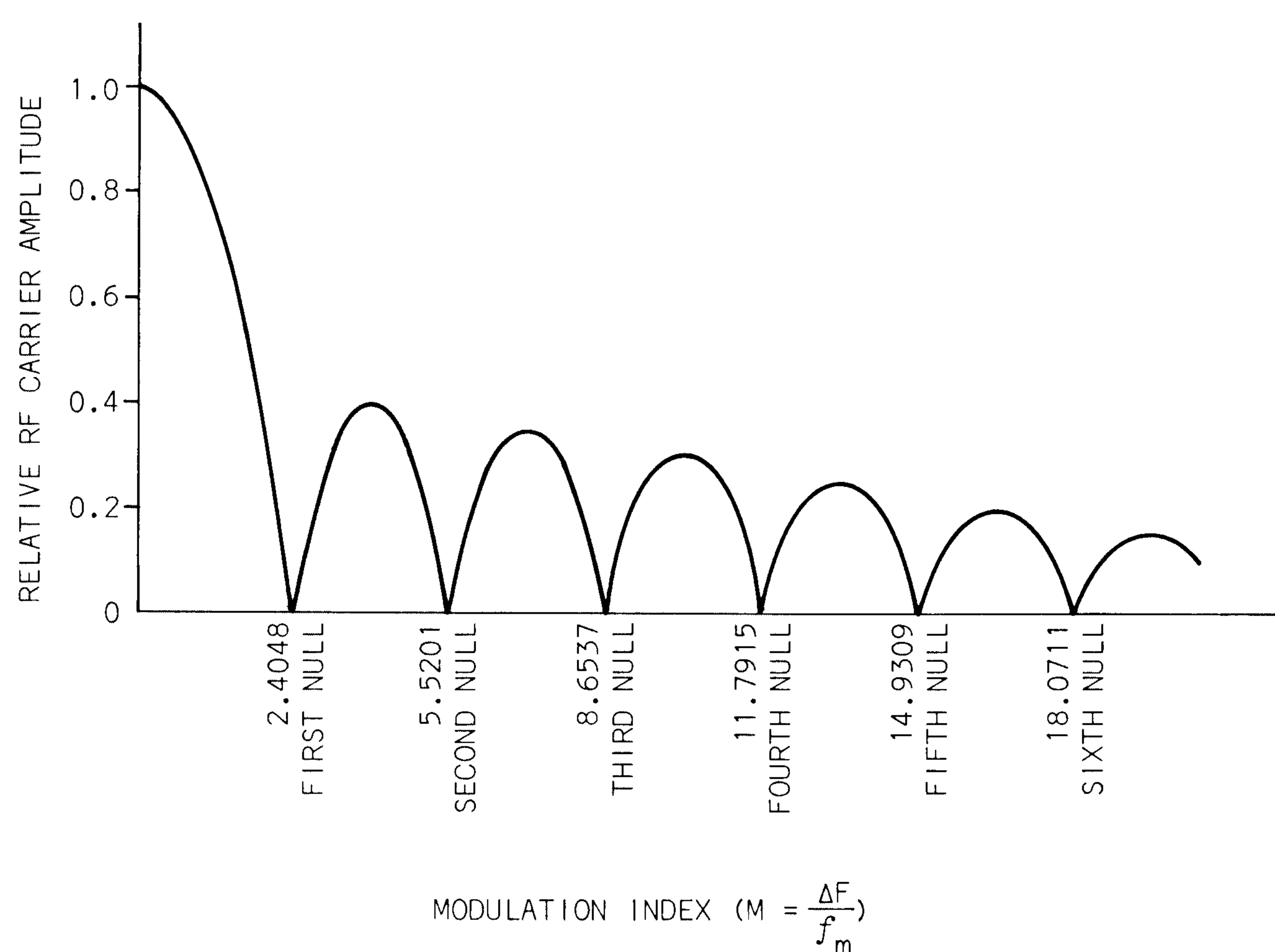


Fig. 8-4. Carrier null versus modulation index.

Dispersion range selection should be made to allow an adequate display of the carrier null signal and whatever additional sidebands may be of interest.

resolution  
control

Resolution amplifier bandwidth narrower than the modulating frequency is necessary if the individual sideband components of an FM modulated signal are to be clearly resolved. The resolution control is coupled with the dispersion control to provide a satisfactory display for most measurements; however, the resolution may be changed easily by simply uncoupling the resolution control from its normal position and adjusting it independently.

measure  
modulation  
index

To ensure that, numerically, the order of the carrier-null not be confused it is recommended that the amplitude of the modulating frequency always be increased from zero level. This will indicate to the observer that for modulation-index values of less than 0.5 only one set of sidebands of significant amplitude appear, each side of the RF carrier, and that it is almost impossible to differentiate a sinusoidal frequency-modulated signal from that of an amplitude-modulated signal. As the amplitude of the modulating frequency is increased, additional sidebands appear on the spectrum analyzer display spaced apart by an amount equal to the modulating frequency. By gradually increasing the amplitude of the modulating signal, the RF carrier will be seen to decrease to zero. This is referred to as the first null. Further increase in amplitude will cause the carrier to reappear, rise to a maximum and decrease to zero again. This will occur periodically with the carrier maxima generally decreasing in amplitude. At the first null the modulation index will be equal to 2.4048. Modulation index values for subsequent carrier nulls are listed in Table 8-1. Knowing the modulation frequency and the order of the null (first, second, third, etc.) the appropriate value of modulation index may be used to compute the desired frequency deviation.

An increase in modulating signal amplitude is always accompanied by the addition of significant sidebands. The higher the modulating frequency becomes, the further apart lie the sidebands and the wider the bandwidth necessary to accommodate the signal. Since the channel bandwidth is limited it becomes necessary to limit the highest modulating frequency and frequency deviation.

deviation  
ratio

Wideband FM broadcast transmitters must limit their carrier frequency deviations to less than  $\pm 75$  kHz and their audio modulating frequency to 15 kHz maximum. The value for the modulation index for which these values are relevant is called the *deviation ratio* and is defined by:

$$\text{Deviation ratio} = \frac{\text{maximum permissible deviation}}{\text{highest modulating frequency}}$$

A  $\Delta f$  of 75 kHz and  $f_m$  of 15 kHz results in a deviation ratio of five. These values, however, do not decrease the RF carrier amplitude to zero and therefore they cannot be used to set the amplitude-limiting control of the modulating frequency for maximum carrier deviation.

transmitter  
frequency  
deviation and  
modulation  
amplitude

Since the maximum frequency deviation is specified and the values of modulation index for carrier null are known, it is a simple matter to compute a modulating frequency which will be within the frequency response bandwidth of the transmitter and also cause the carrier amplitude to decrease to zero at the appropriate frequency deviation. Having chosen the unique modulating frequency, all that remains is to adjust its amplitude so that the carrier amplitude decreases to zero when observed on a spectrum analyzer.

For instance, from Table 8-1 it is seen that the second carrier null occurs at a modulation index of 5.5201. If this modulation index is divided into the maximum carrier deviation allowed, the audio frequency necessary to cause the carrier to decrease to zero will be 13,586 Hz. The measurement then consists of accurately setting the frequency of an audio oscillator and increasing the audio input level control until the carrier decreases to zero level for the second null.

Other frequency-modulation communication services limit carrier deviation to values less than  $\pm 75$  kHz, however the procedure for measuring or setting the transmitter frequency deviation remains essentially the same.

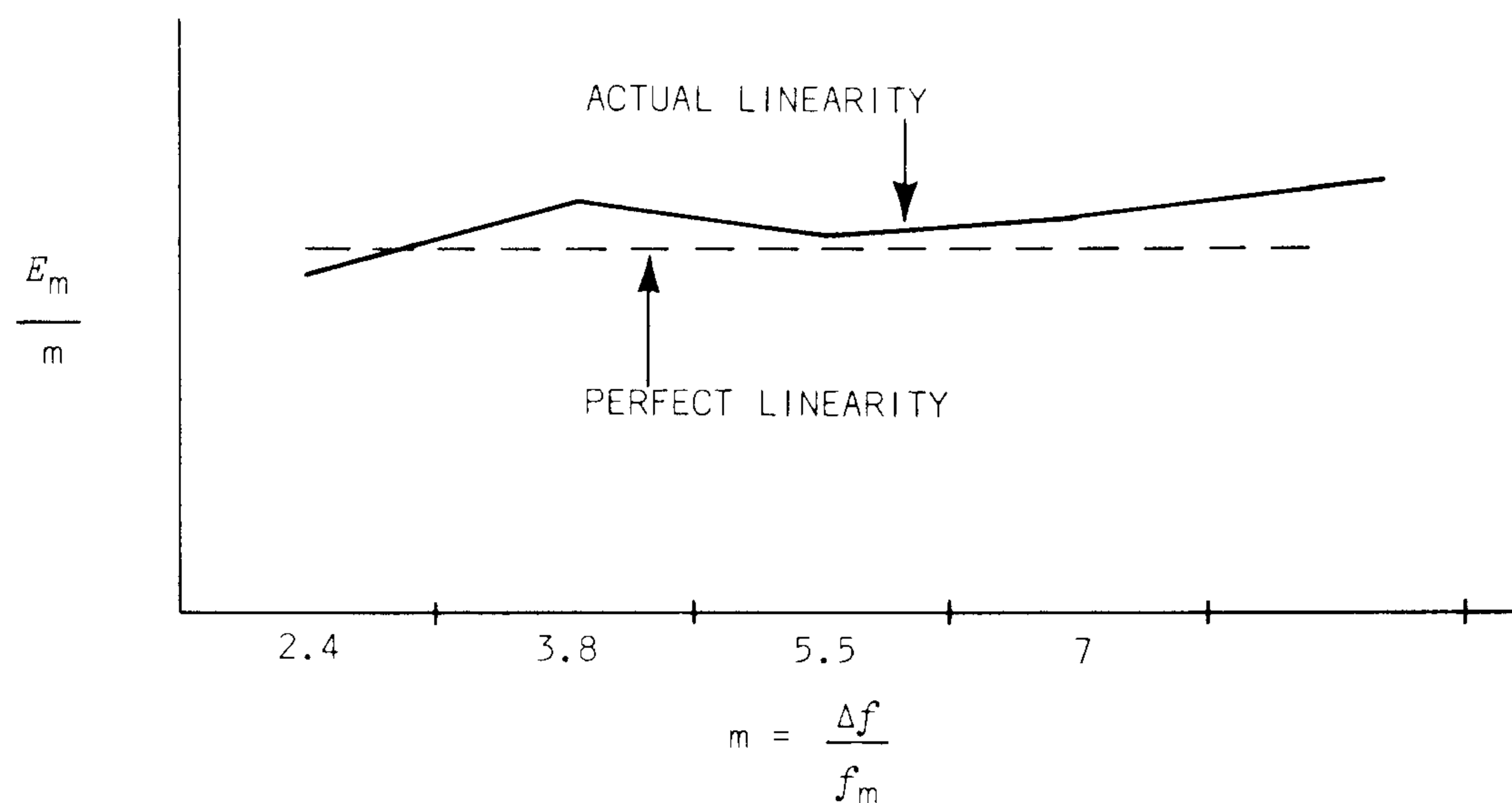


Fig. 8-5. Graphic display of deviation linearity.

## DEVIATION LINEARITY

$\frac{E_m}{m}$  vs  $m$

Deviation linearity is a measure of the nonlinearity, existing in an FM transmitter or signal generator, between the carrier frequency deviation and the voltage amplitude of the modulating frequency causing the deviation. It is described graphically as the ratio of the modulating frequency voltage divided by the modulation index to the modulation index, as shown in Fig. 8-5.

The measurement consists of measuring the voltage amplitude of the modulating frequency for successive carrier and sideband nulls for as many values of modulation index as desired. A spectrum analyzer capable of high resolution and low incidental FM is used to display the signal nulls while the amplitude of the modulating frequency may be measured accurately with low frequency oscilloscope or a digital AC voltmeter. See Fig. 8-6.

Ratios of modulating frequency voltage divided by modulation index are plotted vertically and the values of modulation index plotted horizontally to graphically display the degree of nonlinearity which may be present. Ideally the curve should represent a horizontal straight line for the complete range of modulation index values.

Fig. 8-5 shows a graphical representation of the nonlinearity measured on a typical klystron high-frequency FM oscillator. The amount of nonlinearity is not affected by changing modulation frequencies. Fig. 8-7 shows the nulls as measured on a Type 491 Spectrum Analyzer for the carrier, first and second sidebands of an FM 3 GHz carrier.

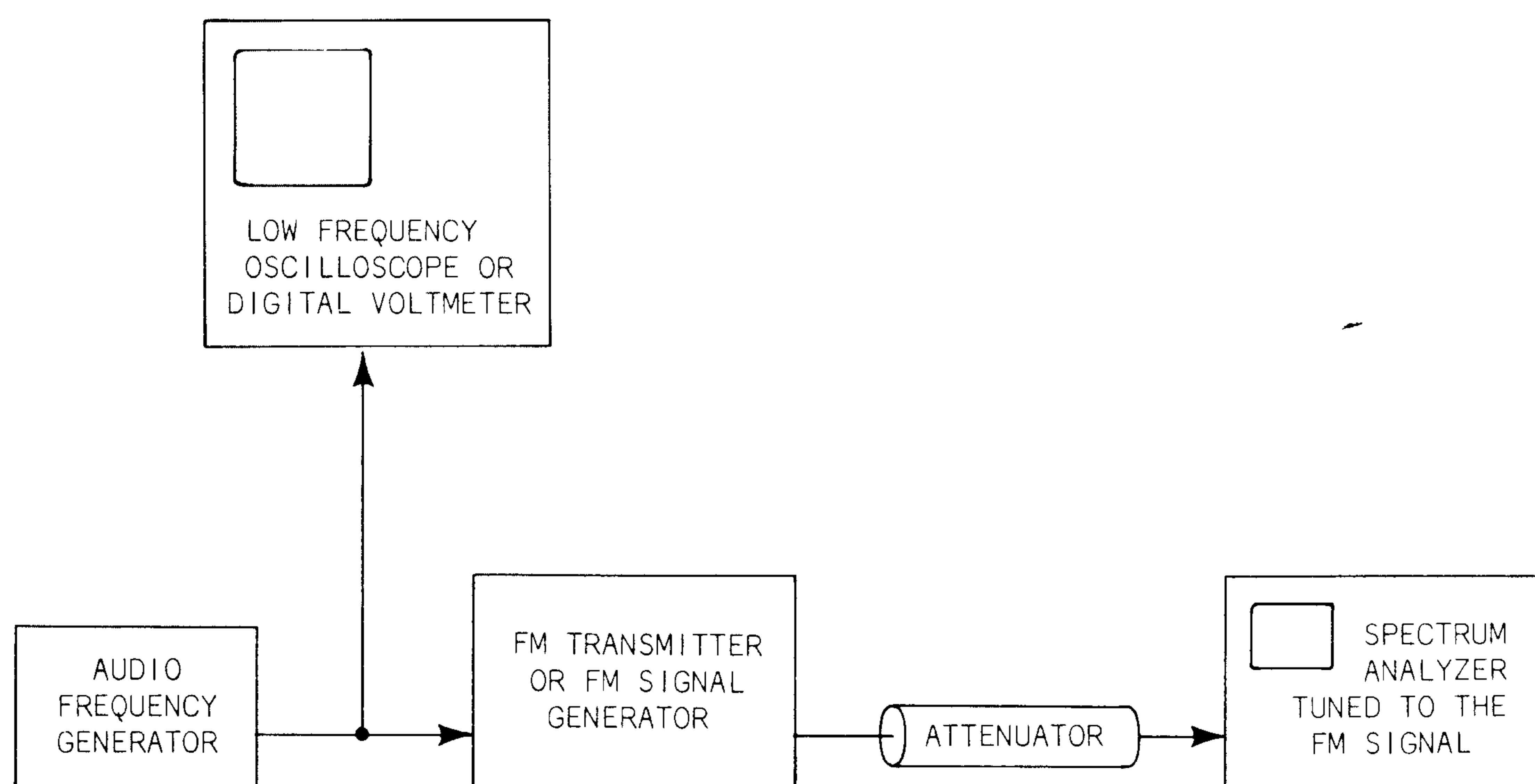
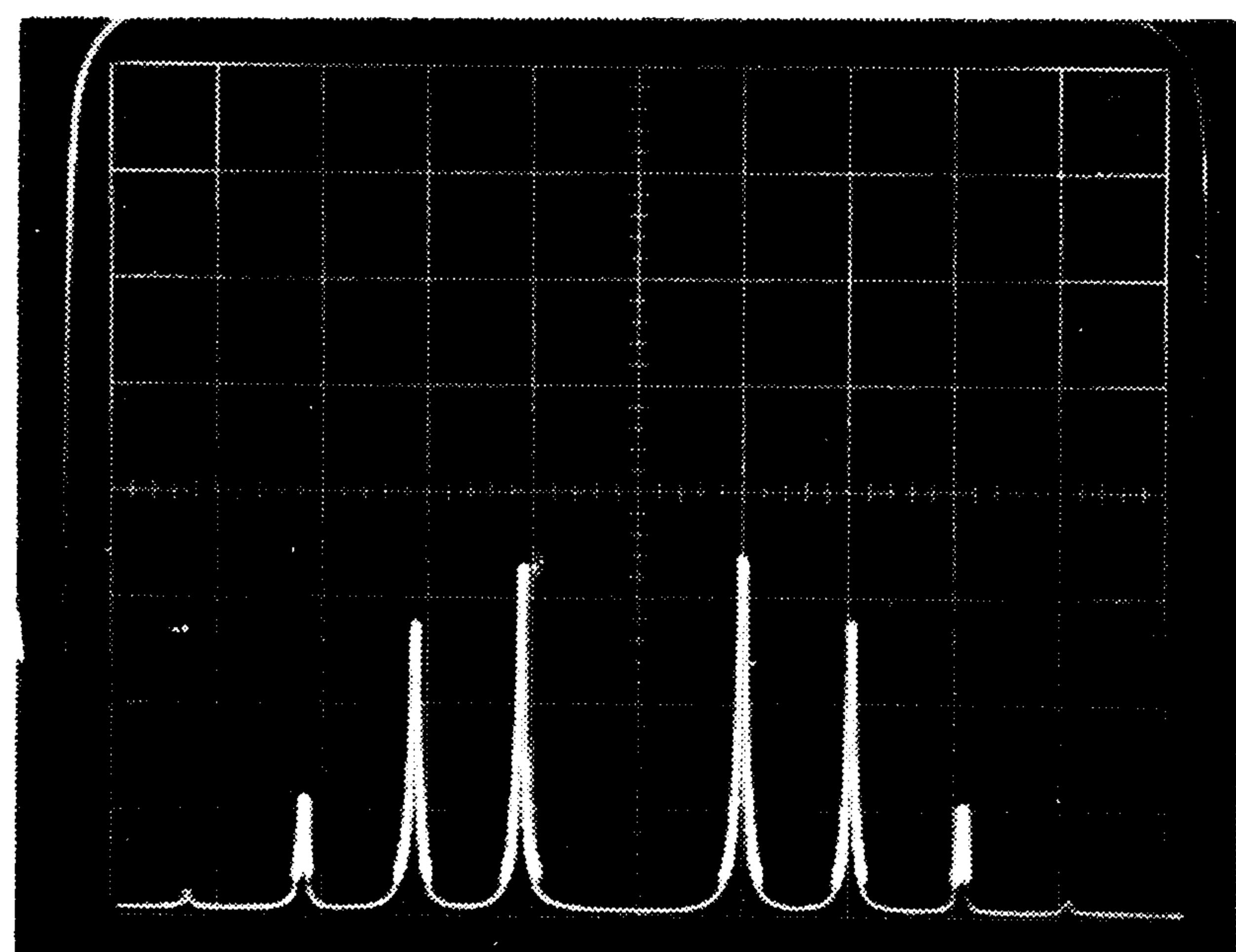
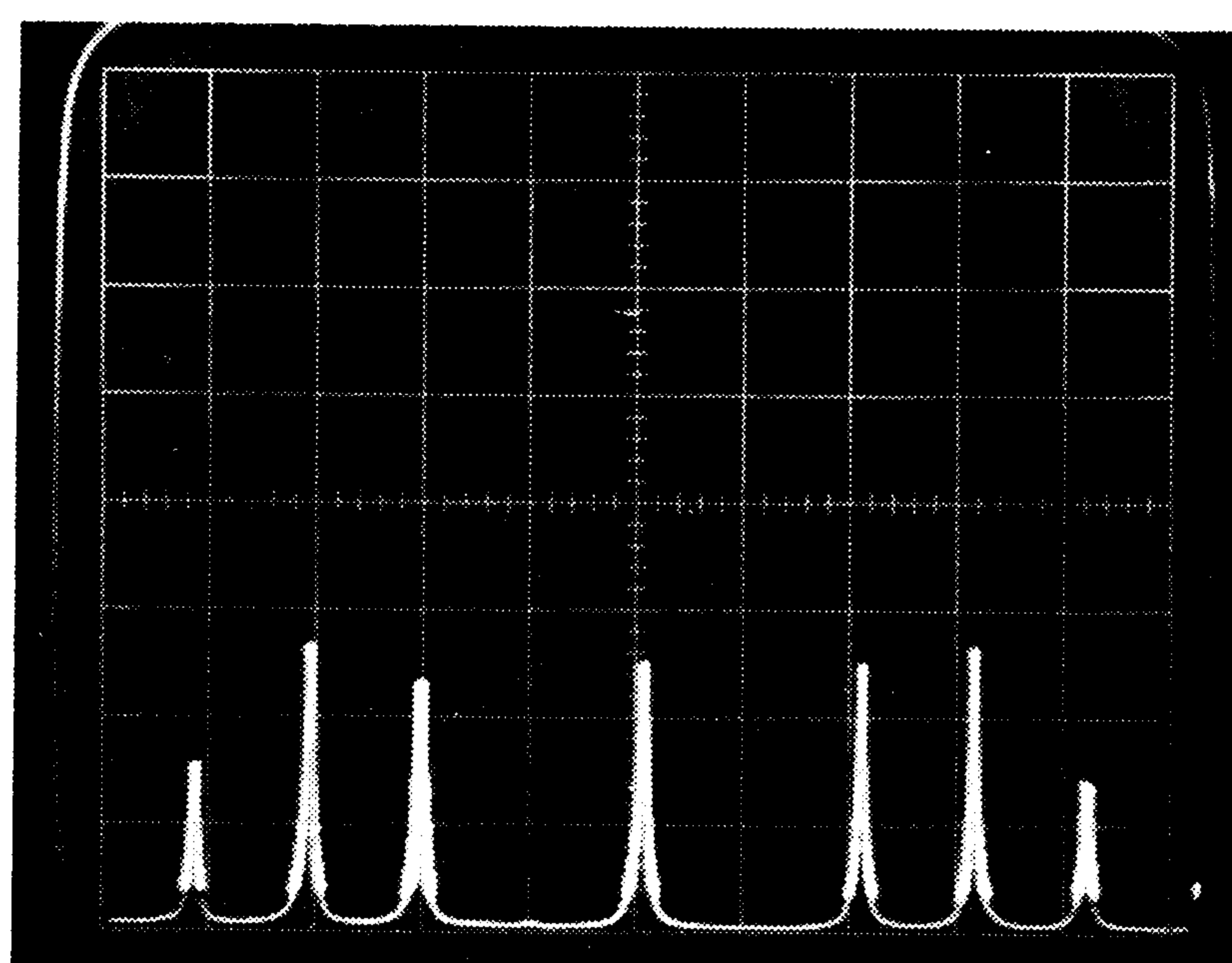


Fig. 8-6. FM deviation linearity measurement.



(A) CARRIER NULL



(B) FIRST SIDEBAND NULLS



(C) SECOND SIDEBAND NULLS

Fig. 8-7. Deviation linearity display.



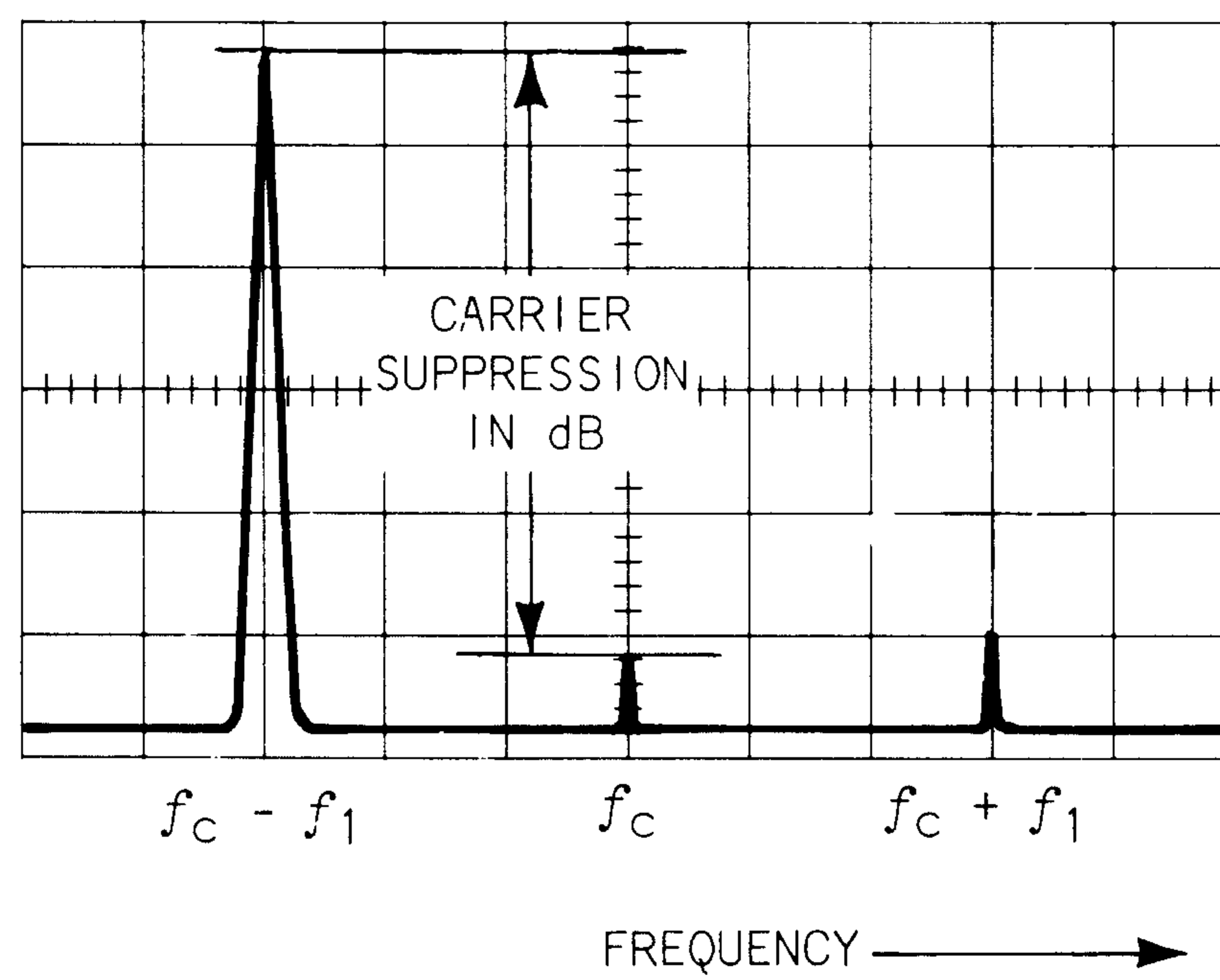
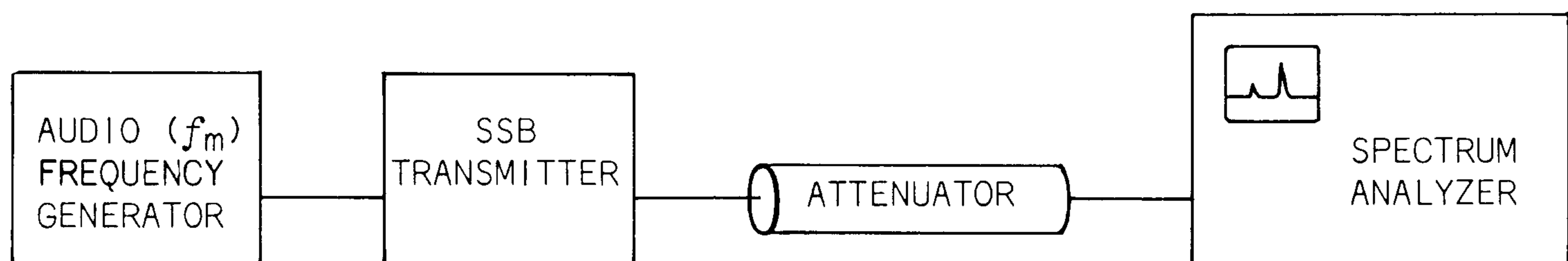


Fig. 9-1. Carrier suppression measurement.

## 9

SINGLE-SIDEBAND  
MEASUREMENTS

## CARRIER SUPPRESSION

Carrier suppression is a measure of the RF carrier power amplitude relative to the RF peak-envelope-power (PEP) rating of a single-sideband transmitter. The most common method of measuring carrier suppression is to apply a suitably attenuated 1-kHz modulated single-sideband RF signal to the input of a spectrum analyzer (Fig. 9-1). The 1-kHz modulating frequency establishes a reference level which drives the transmitter to its rated RF peak envelope power. The carrier signal will be severely attenuated 1 kHz away from the reference sideband. Since the amount of carrier suppression may range between 40 to 60 dB it will be necessary to use the vertical log display mode of the spectrum analyzer.

signal  
overload  
generates  
spuri

This measurement requires a large vertical-display dynamic range as well as high spurious-signal rejection capability of the spectrum analyzer. Care must be exercised that the maximum useful dynamic range is not exceeded since the slightest amount of signal overload will create large numbers of spurious frequency components associated with the signal. These frequency components will make identification of the carrier signal difficult. The amplitude ratio between the transmitted sideband and the carrier level is a measure of the carrier suppression capabilities of the transmitter. The magnitude is generally expressed in decibels.

The intermodulation capability of the spectrum analyzer is not a consideration in this measurement because only one large signal is being applied to the spectrum analyzer.

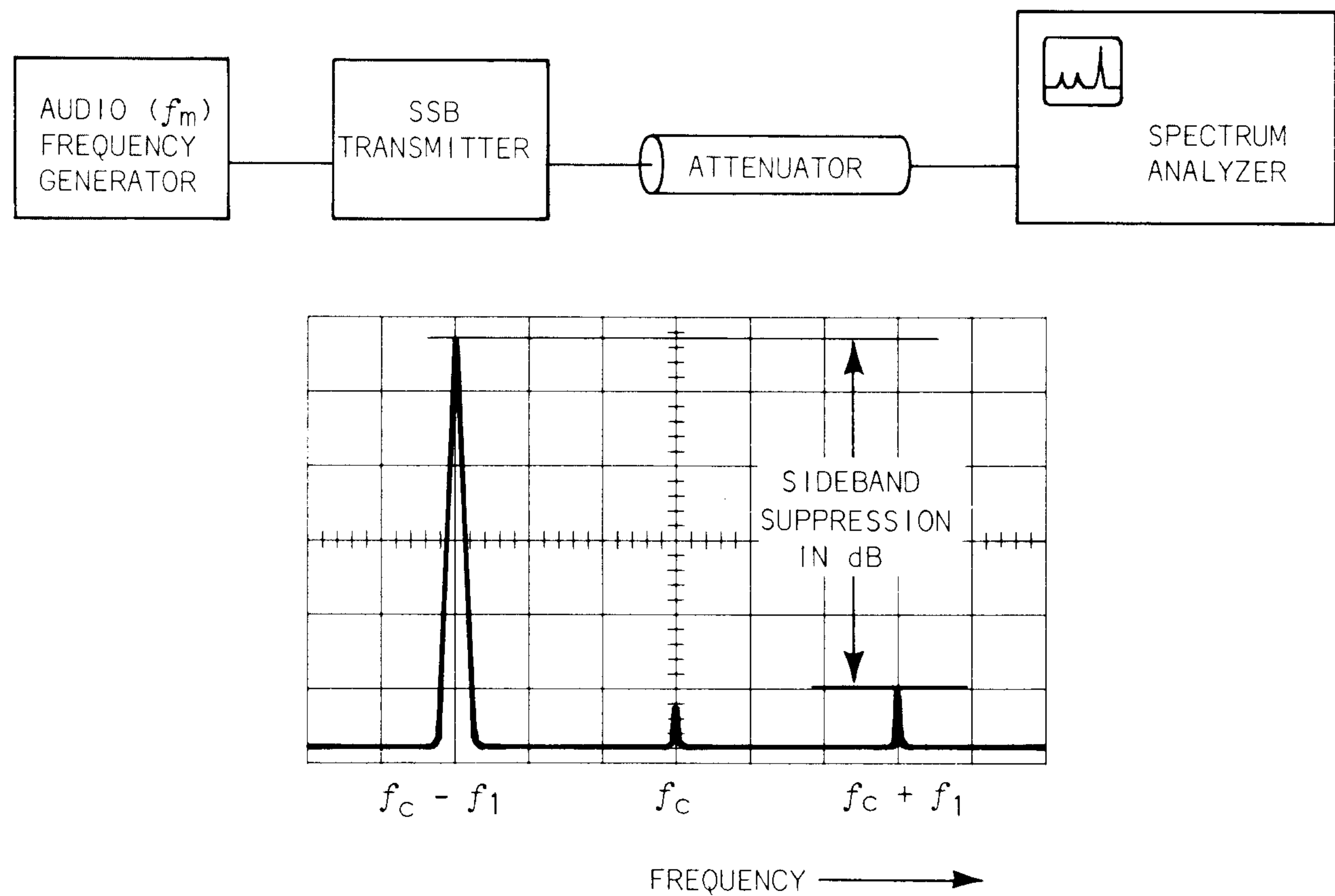


Fig. 9-2. Sideband suppression measurement.

## SIDE BAND SUPPRESSION

Sideband suppression is a measurement of the ratio of the amplitude of a desired sideband to its counterpart in the opposite sideband, expressed in dB (Fig. 9-2). This ratio may vary greatly across the audio-signal spectrum. In filter-type single-sideband transmitters, the sideband suppression is a function of the filter selectivity (frequency response). The amount of suppression is lowest for low audio frequencies and increases rapidly with audio frequency. For this reason sideband suppression is usually specified and measured at specific audio frequencies such as 400 Hz or 1 kHz. A complete audio spectrum measurement is very seldom performed since it would require measurements to be taken at a sufficient number of frequencies across the audio passband to plot a curve of sideband suppression versus modulating frequency.

All of the spectrum analyzer specifications which applied to the carrier suppression measurements also apply to the sideband suppression measurement.

## SIGNAL TO DISTORTION OR INTERMODULATION DISTORTION MEASUREMENT

The signal-to-distortion ratio (S/D) or intermodulation distortion generated in a SSB system may be conveniently measured using a 2-tone audio-frequency modulating signal and a spectrum analyzer tuned to the output frequency of the SSB transmitter.

two-tone  
test method

In a perfectly linear SSB system, two equal-amplitude audio modulating frequencies should produce a display of two equal-amplitude RF components separated in frequency equivalent to the difference between the modulating frequencies. If nonlinearity is present, the spectrum analyzer will display other frequency components adjacent to the reference signals (Fig. 9-3). The distortion frequency components can easily be identified by their lower relative amplitude, frequency separation and position in the frequency spectrum adjacent to the reference signals (Fig. 9-4). The frequency components nearest the reference signals are the result of the second harmonic of one of the reference signals mixing with the fundamental frequency of the other. The nonlinearity within the SSB system causes the second

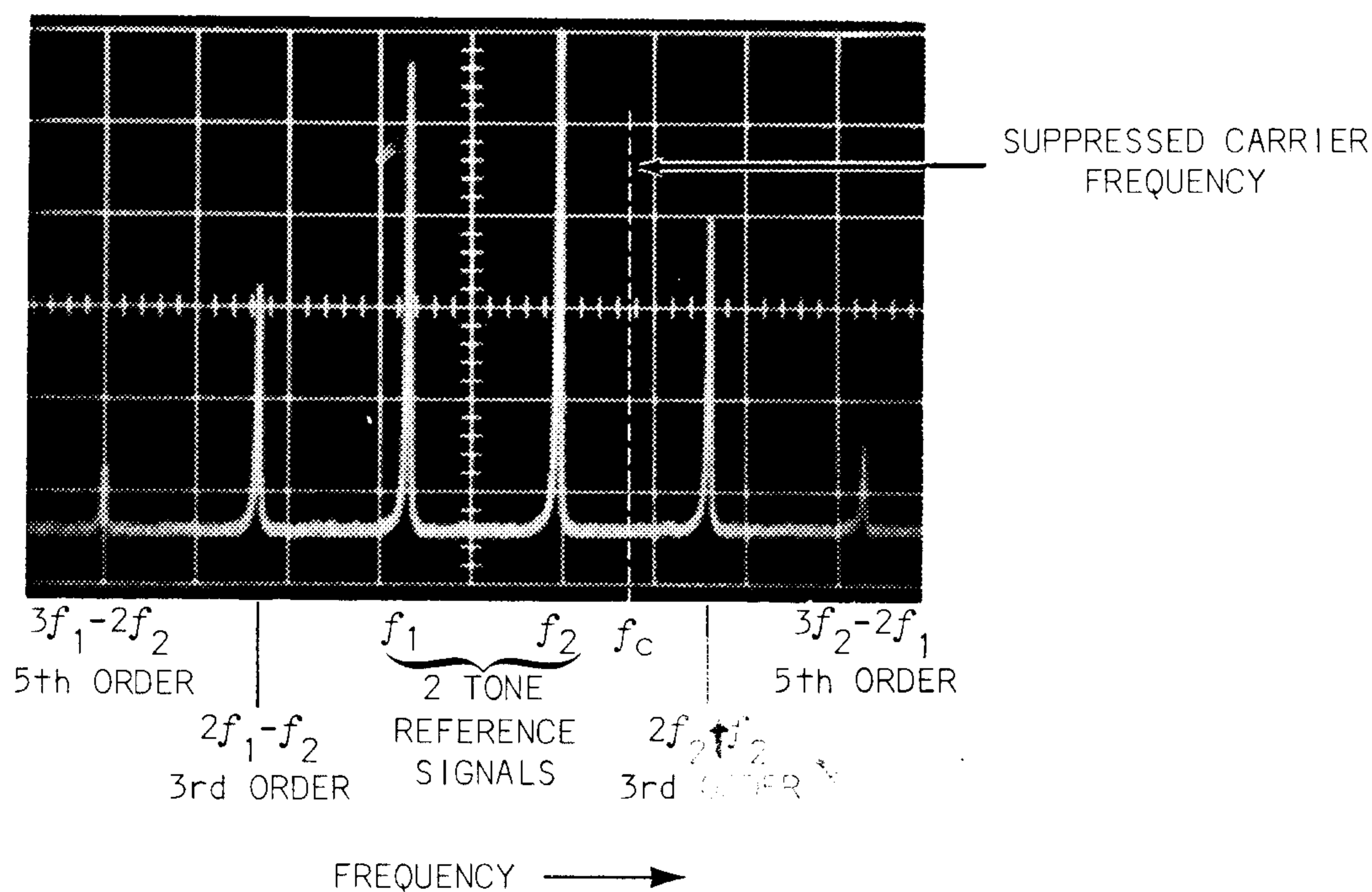


Fig. 9-3. Spectrum distribution of odd order intermodulation distortion products.

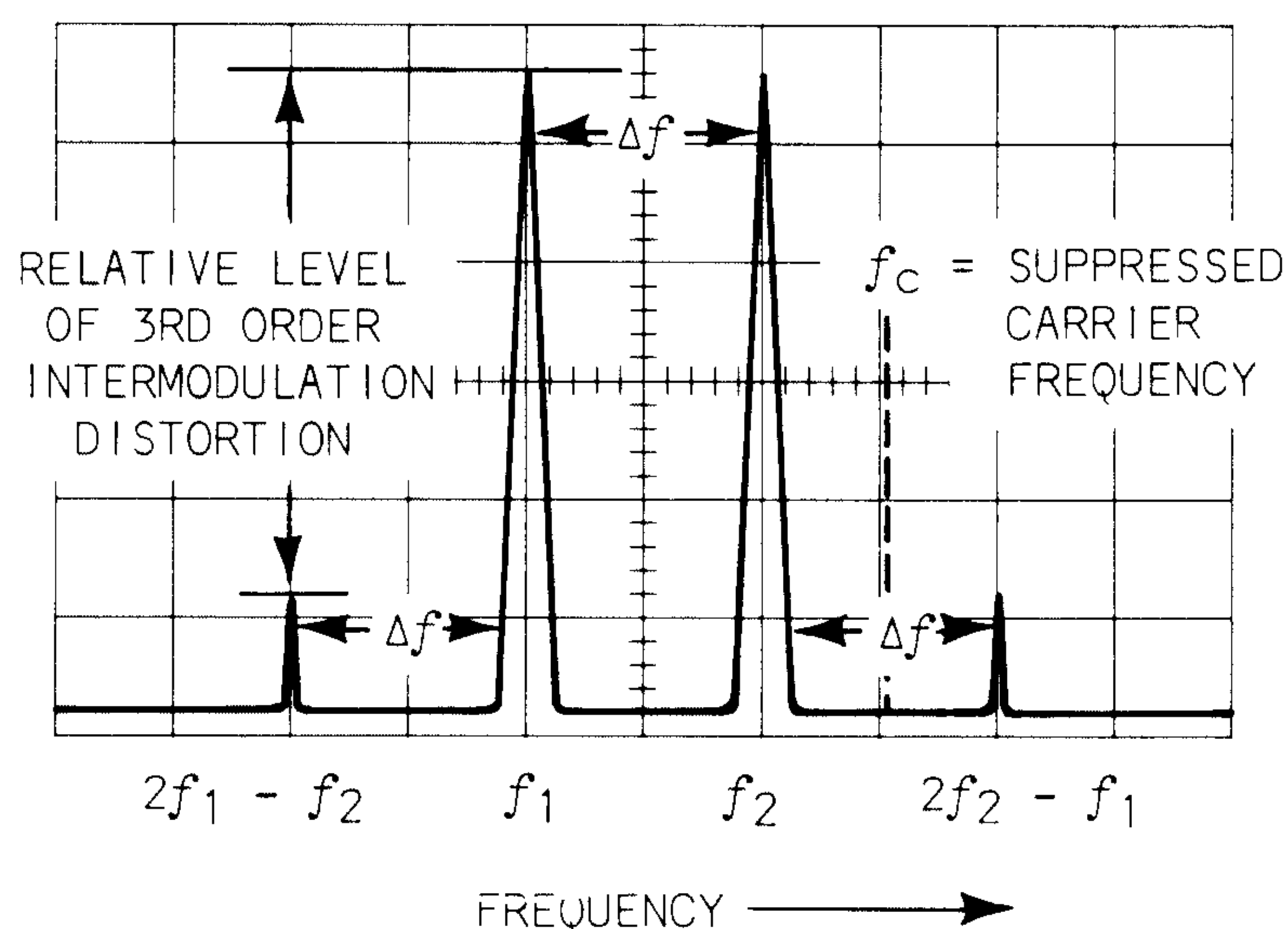
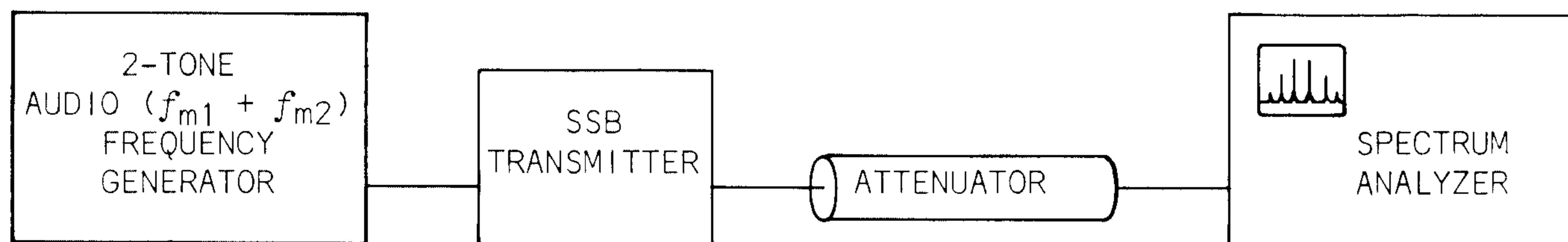


Fig. 9-4. Intermodulation or signal-to-distortion measurement.

distortion  
from  
odd order  
products

and higher order harmonics of the RF fundamental frequencies to be generated. They mix with each other due to the nonlinearity in the amplifier to generate additional output signals not present at the input. Even-order frequency components fall outside of the bandpass frequency response of the tuned circuits and therefore do not appear in the output. Excessive distortion may result in the third, fifth, seventh and possibly ninth order of frequency components being generated. Since the third order intermodulation frequency components develop the largest amount of distortion, their amplitude relative to the displayed reference signals is usually specified in the performance of SSB equipment.

The two-tone test signal is the most widely used method of testing SSB transmitters and has been adopted by all SSB equipment manufacturers as the standard test method. The two-tone test generator requirements are purity of signal with very low distortion. The spectrum analyzer must provide good frequency stability, narrow dispersion, high resolution, large vertical dynamic range, low spurious frequency response and low intermodulation distortion.

signal  
envelope

The measurement is performed with the SSB transmitter adjusted for rated average power output. Two equal-amplitude audio tones, separated in frequency by approximately 1 kHz or less, are then applied to the transmitter input. The resultant signal envelope will cause the transmitter output to vary from zero to maximum over the entire amplitude dynamic range of the amplifier generating the rated peak envelope power (PEP) of the transmitter. Distortion is most likely to occur when peak envelope power levels are approached.

A suitably attenuated sample of the SSB RF output signal is applied to the input of the spectrum analyzer. The controls are adjusted to display the amplitude of the reference signal frequencies over the full height of the graticule using the vertical log-display mode. The dispersion and resolution controls are adjusted to display a spectrum width sufficient to include all of the intermodulation frequency components of interest.



third order  
components

The height of the largest intermodulation frequency component (third order) is noted and the front panel attenuators are used to attenuate the reference RF signals to the previous level of the third order intermodulation frequency components. The amount of attenuation in dB required to attenuate the reference signal is a measure of the relative level of third-order intermodulation distortion generated within the SSB system. A level of 30 dB below the desired signal is often considered acceptable, however, SSB systems with 40 to 50 dB of intermodulation rejection are not uncommon. It is often required to specify the levels of higher orders of intermodulation distortion relative to the desired signals. This places greater demands on the specifications required of spectrum analyzers.

If the third-order distortion cannot be seen on the spectrum analyzer as described, the intermodulation distortion capability of the SSB system is sometimes simply stated as greater than the vertical display dynamic range of the spectrum analyzer used for the measurement.

heterodyne  
it down  
to lower  
frequency

Microwave spectrum analyzers of the swept IF type which are capable of tuning through the SSB RF communication spectrum generally do not provide sufficient intermodulation rejection, display dynamic range, frequency stability or resolution capability to adequately display and measure the characteristics of SSB signals. An economical and practical method of solving the measurement problem is to utilize the superior instrument characteristics of low-frequency spectrum analyzers by converting the SSB RF spectrum signal into the RF center-frequency tuning range of the low-frequency spectrum analyzer. This technique requires the use of an external local oscillator and double-balanced mixer.

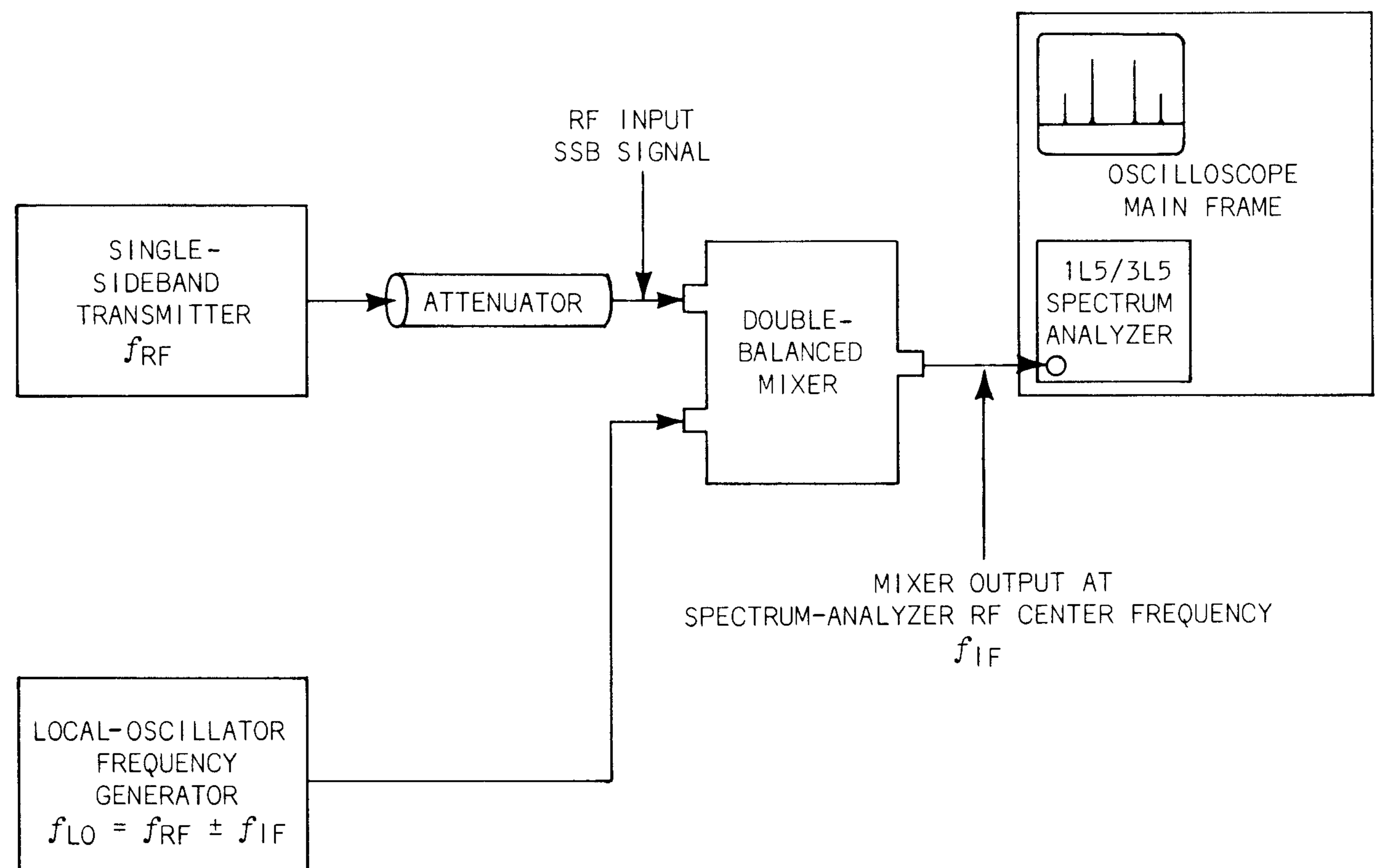


Fig. 9-5. Method of measurement of intermodulation distortion using Tektronix Type 1L5 or 3L5 Spectrum Analyzer, external LO signal generator and double-balanced mixer.

The method of measurement is outlined in block form using a Tektronix 1L5 or 3L5 spectrum analyzer in an appropriate main frame oscilloscope in Fig. 9-5. Both double-balanced mixers and RF signal generators with adequate specifications for stable and undistorted frequency conversion are available commercially. The measurement technique is essentially identical to that already discussed. The external local oscillator must be tuned to an RF center frequency above or below the SSB signal frequency by  $\Delta f$  equal to the frequency of the spectrum analyzer. The mixer IF output signal will then fall in the bandpass of the center frequency tuning range of the spectrum analyzer.

This method of measurement is applicable to a wide variety of RF signals which require equivalent spectrum analyzer specifications.

## 10

PULSED RF CARRIER  
MEASUREMENTS

The most important operating characteristics to be determined from a pulsed RF spectrum are:

1. Pulse duration ( $t_p$ ).
2. Pulse repetition frequency ( $PRF$ ).
3. Relative power distribution.
4. Incidental AM and FM.
5. RF pulse on-off ratio.

In all of the above measurements the signal level applied to the spectrum analyzer should not exceed -30 dBm maximum. When a spectrum analyzer is used to display the RF spectrum of a radar transmitter, a sample of the transmitted signal is usually available through a built-in directional coupler with at least 30 dB of attenuation, Fig. 10-1. Most radars have built-in couplers which provide approximately a milliwatt of test output signal from the transmitter.

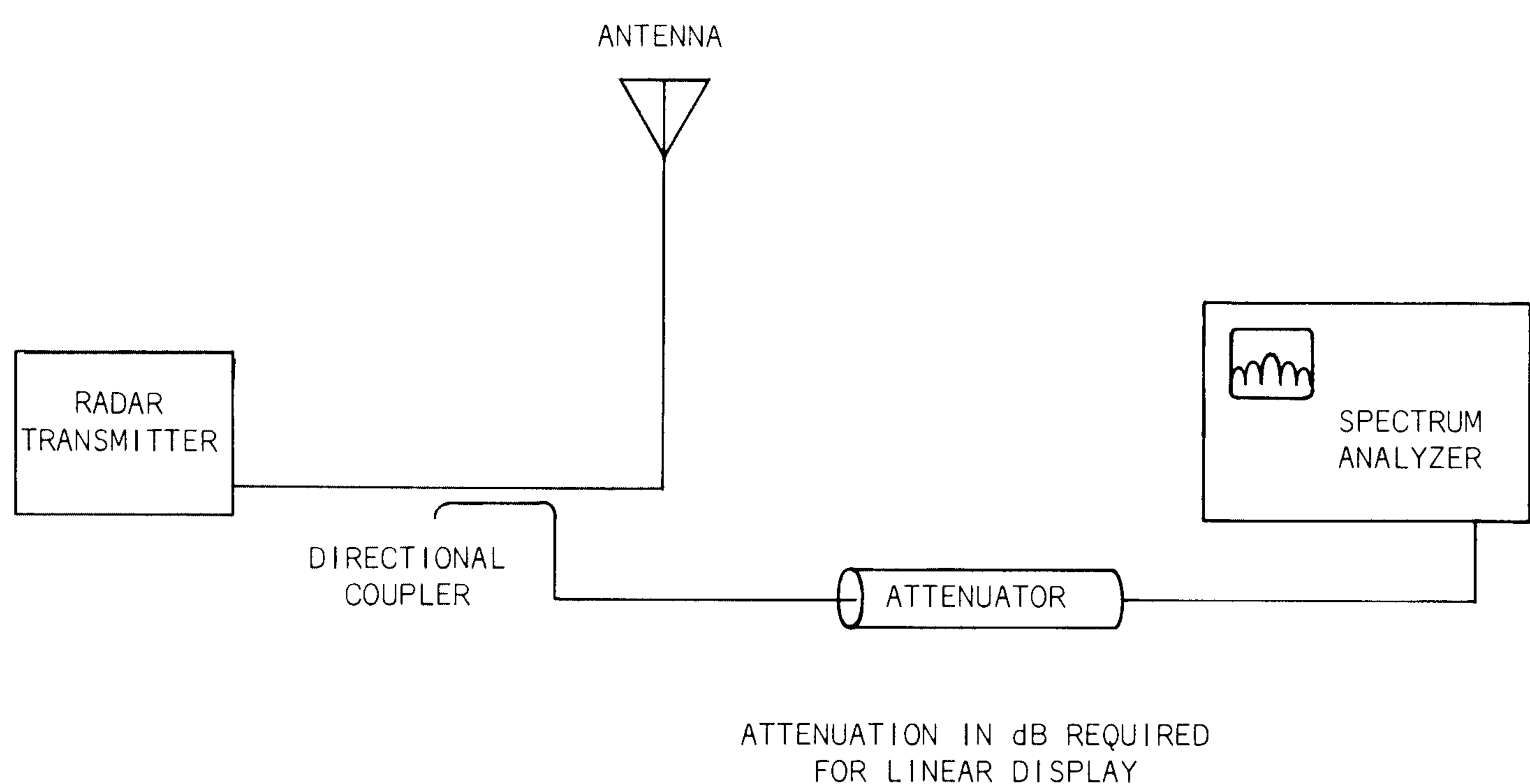


Fig. 10-1. Method of measuring the characteristics of a pulsed RF spectrum generated by a radar transmitter.

display  
major lobe

When applying the test signal from an operating radar the spectrum analyzer should be tuned to the transmitter frequency which will display the major lobe of the radar's pulse spectrum in the center of the display graticule.

test for  
overload

A test for front-end mixer signal overload conditions should be performed to ensure an undistorted display of the RF spectrum. To accomplish the check, insert 10 dB of external attenuation ahead of the spectrum analyzer input. If overload is not present the amplitude of the lobe envelope should decrease by 10 dB on the spectrum analyzer display. If the amplitude level should decrease less than 10 dB some overload is present and an additional amount of signal attenuation should be inserted until the decrease in the amplitude display is equal to the amount of attenuation used. When graticules are not calibrated, the front-panel attenuator may be used in conjunction with the IF attenuator or gain control by increasing one and decreasing the other. If no distortion is present in the spectrum analyzer, the signal level on the CRT will remain constant within the limits of attenuator accuracy.

The resolution should be made as wide as possible to start with to ensure maximum display amplitude and decreased as necessary.

display  
size

The dispersion should be adjusted for a display of the major lobe centered in the middle of the graticule with approximately two minor lobes to each side. This size of display of the pulsed RF spectrum will be sufficient to measure all of the spectrum characteristics. Since most radars use rectangular as opposed to triangular or trapezoidal pulses, the following discussion emphasizes the measurements needed for rectangular pulses.

## MEASUREMENT OF RF PULSE DURATION

The approximate duration (pulse width) of an RF pulse may be computed by calculating the value of the reciprocal of the frequency interval between adjacent minor lobe minima or one-half of the frequency interval between the major lobe minima (Fig. 10-2):

$$t_d = \frac{1}{\Delta f}$$

where  $t_d$  = RF pulse duration in units of time  
and  $\Delta f$  = frequency interval measured between minor lobe minima or one-half of the frequency interval between major lobe minima.

Thus, if the minor lobe minima are spaced at 1 MHz intervals the RF pulse duration is equivalent to:

$$t_d = \frac{1}{1 \times 10^6} \text{ Hz}$$

$$t_d = 1 \times 10^{-6} \text{ seconds}$$

$$t_d = 1 \text{ microsecond}$$

A frequency interval of 2 MHz would indicate an RF pulse duration of 500 nanoseconds.

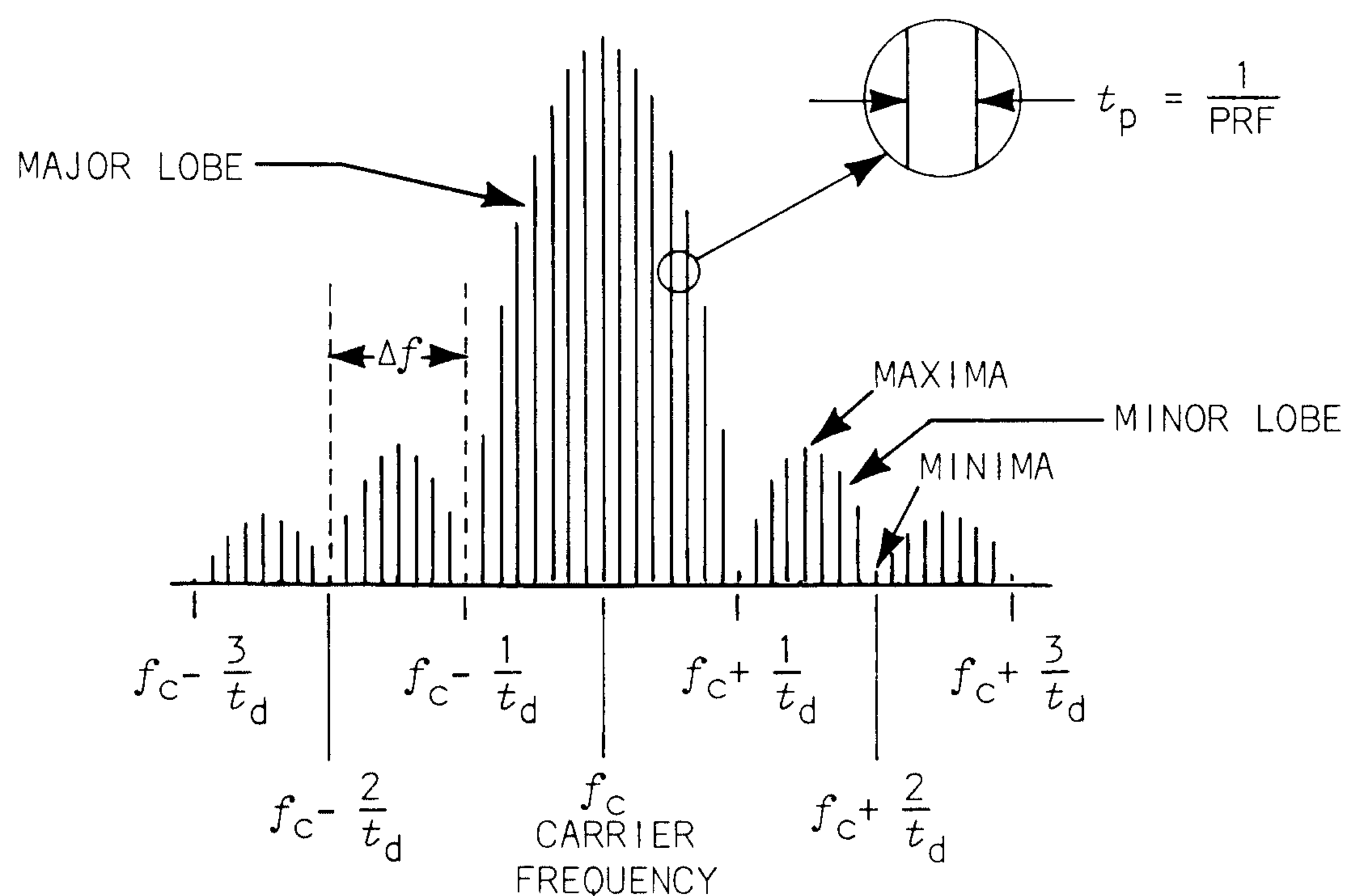


Fig. 10-2. Pulsed RF spectrum display.



The method as performed with a Tektronix Type 1L20, 1L40 or 491 Microwave Spectrum Analyzer consists in measuring the spacing in divisions between adjacent minor lobe minima or one-half of the division spacing between the major lobe minima and multiplying the spacing by the appropriate calibrated dispersion scale factor. This will result in a value for  $\Delta f$  from which the magnitude of the RF pulse duration may be computed.

#### MEASUREMENT OF PULSE REPETITION FREQUENCY

PRF  
measurement

The pulse repetition frequency (PRF) of a repetitive RF pulse may be computed by accurately measuring the time between RF pulses (Fig. 10-3) on a spectrum analyzer and computing the PRF from the expression:

$$\text{PRF} = \frac{1}{t_p}$$

where PRF = pulse repetition frequency  
of the RF pulse.

$t_p$  = time between RF pulses  
(pulse period).

The method as performed with a Tektronix Type 1L20, 1L40 or 491 Microwave Spectrum Analyzer consists in positioning the major lobe to the center of the graticule and decreasing the kHz-range calibrated-dispersion control to zero. The resolution control is uncoupled and turned completely clockwise to provide the widest resolution amplifier bandwidth. The trigger source switch is positioned to the internal signal source position. The polarity switch is set for positive slope triggering. The trigger level control is adjusted for a signal display on the screen. The time per centimeter or division control is adjusted for a satisfactory pulse display measurement.

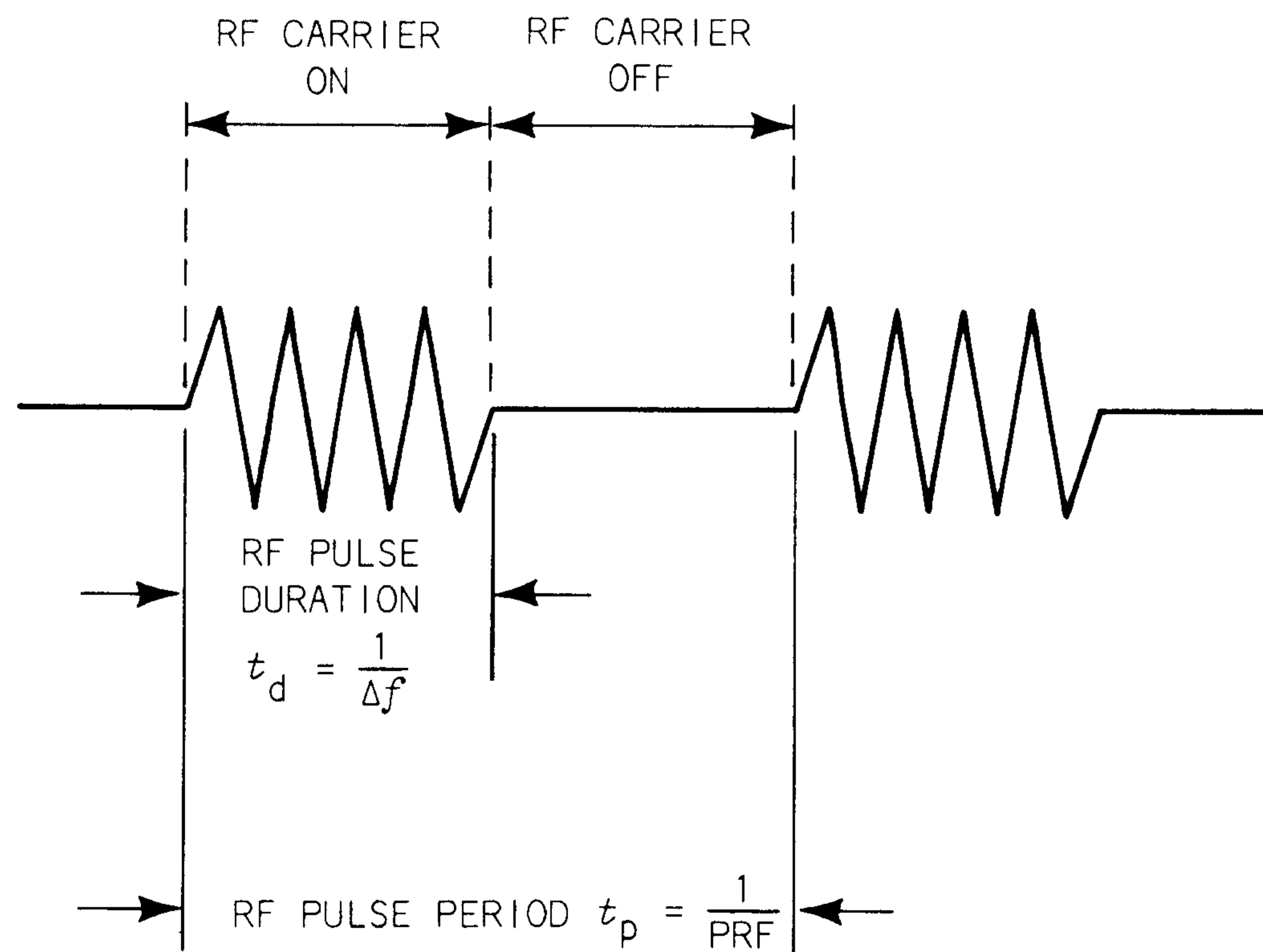


Fig. 10-3. Pulsed RF signal.

For accurate pulse period ( $t_p$ ) measurements the variable time per centimeter or division control must be in its calibrated position. In all Tektronix oscilloscopes and the Type 491 Spectrum Analyzer, attention is drawn to this control by its red color. The reciprocal of the time in units per graticule division, multiplied by the appropriate time per centimeter or division scale factor for two successive pulse displays is equivalent to the RF pulse period  $t_p$  (Fig. 10-4). By using the value of  $t_p$  in the above expression, the pulse repetition frequency for the RF pulse can be computed.

$$t_p = \text{NUMBER OF SCALE DIVISIONS} \times \text{TIME/DIVISION}$$

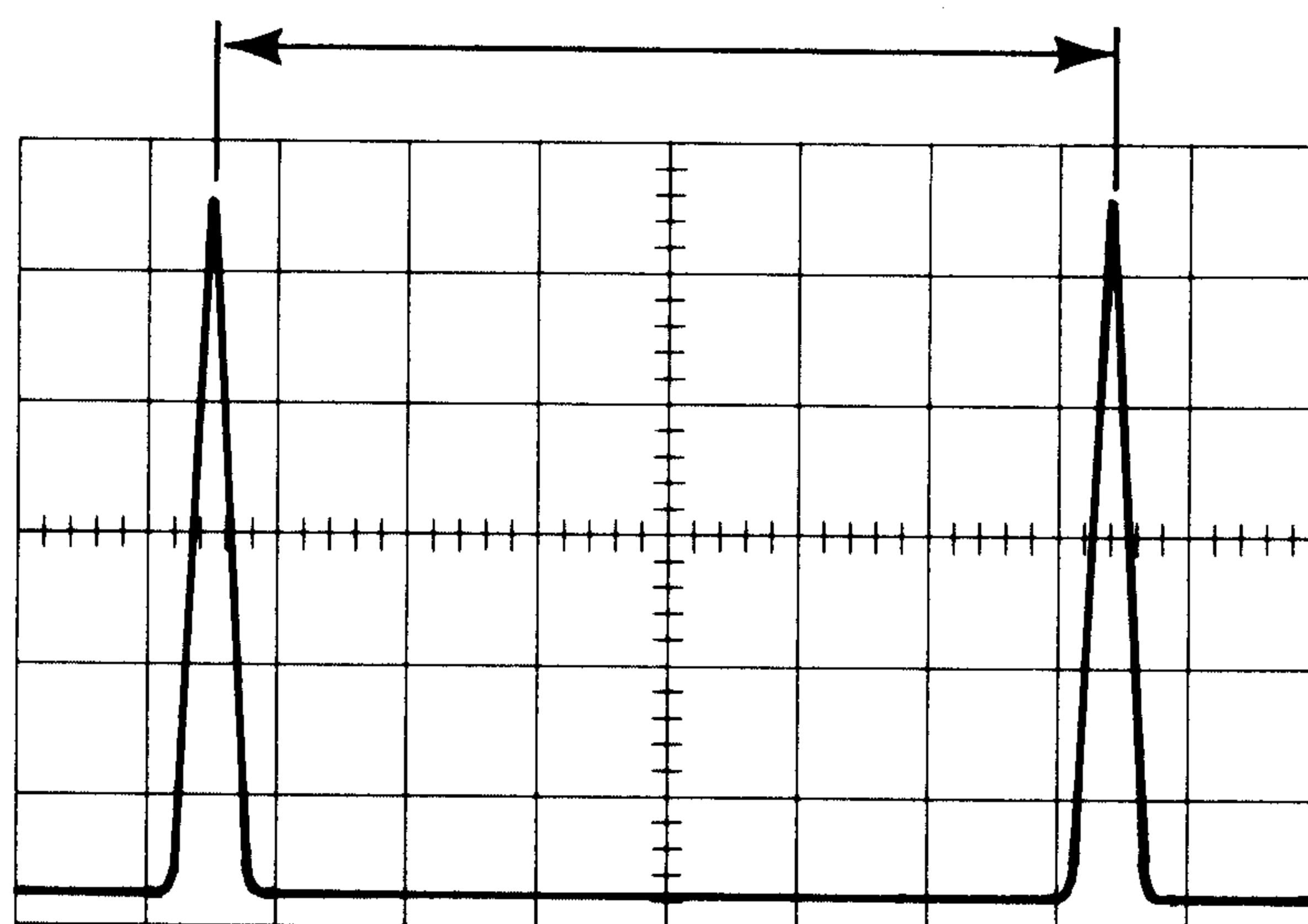


Fig. 10-4. Pulse period ( $t_p = \frac{1}{\text{PRF}}$ ) measurement.

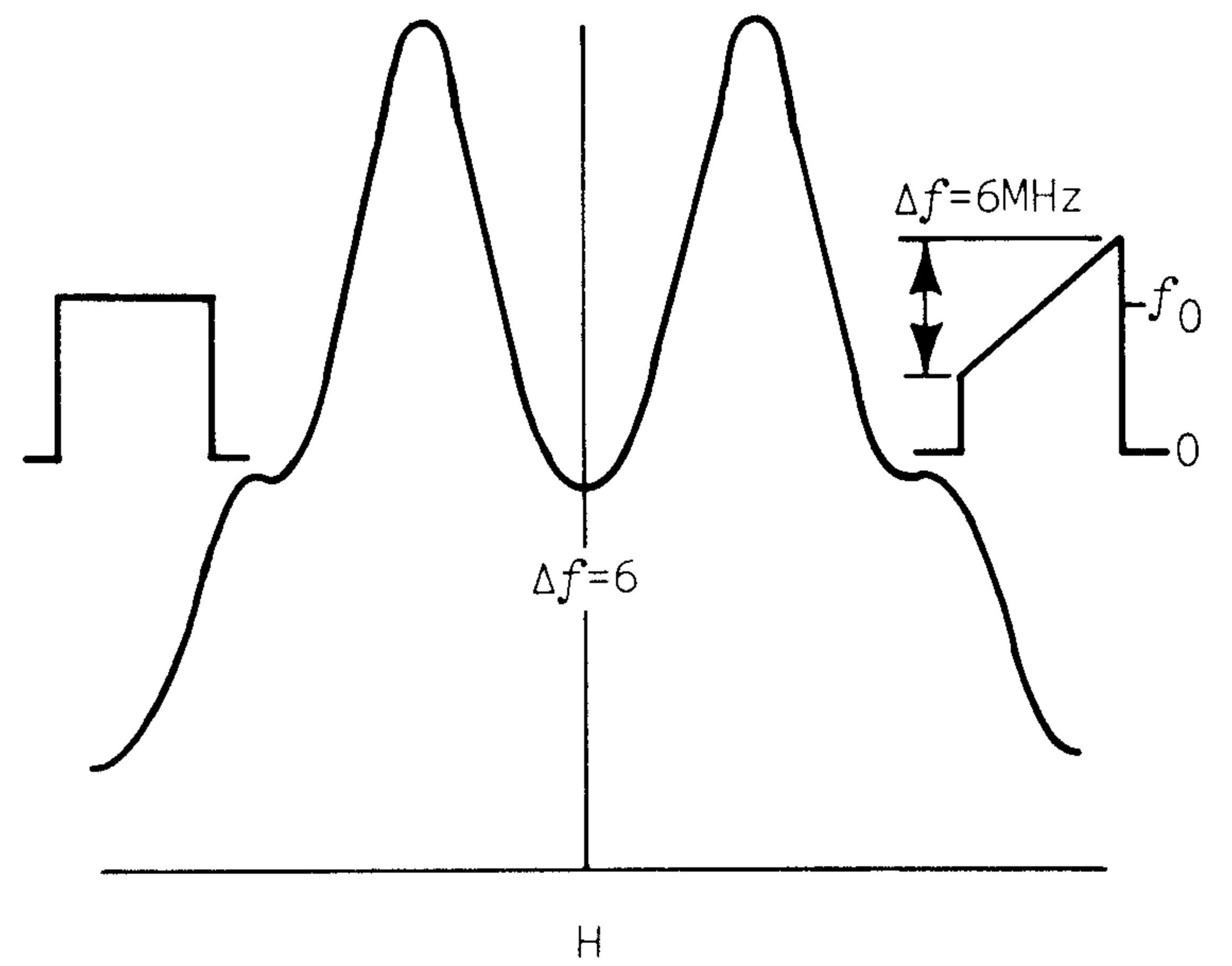
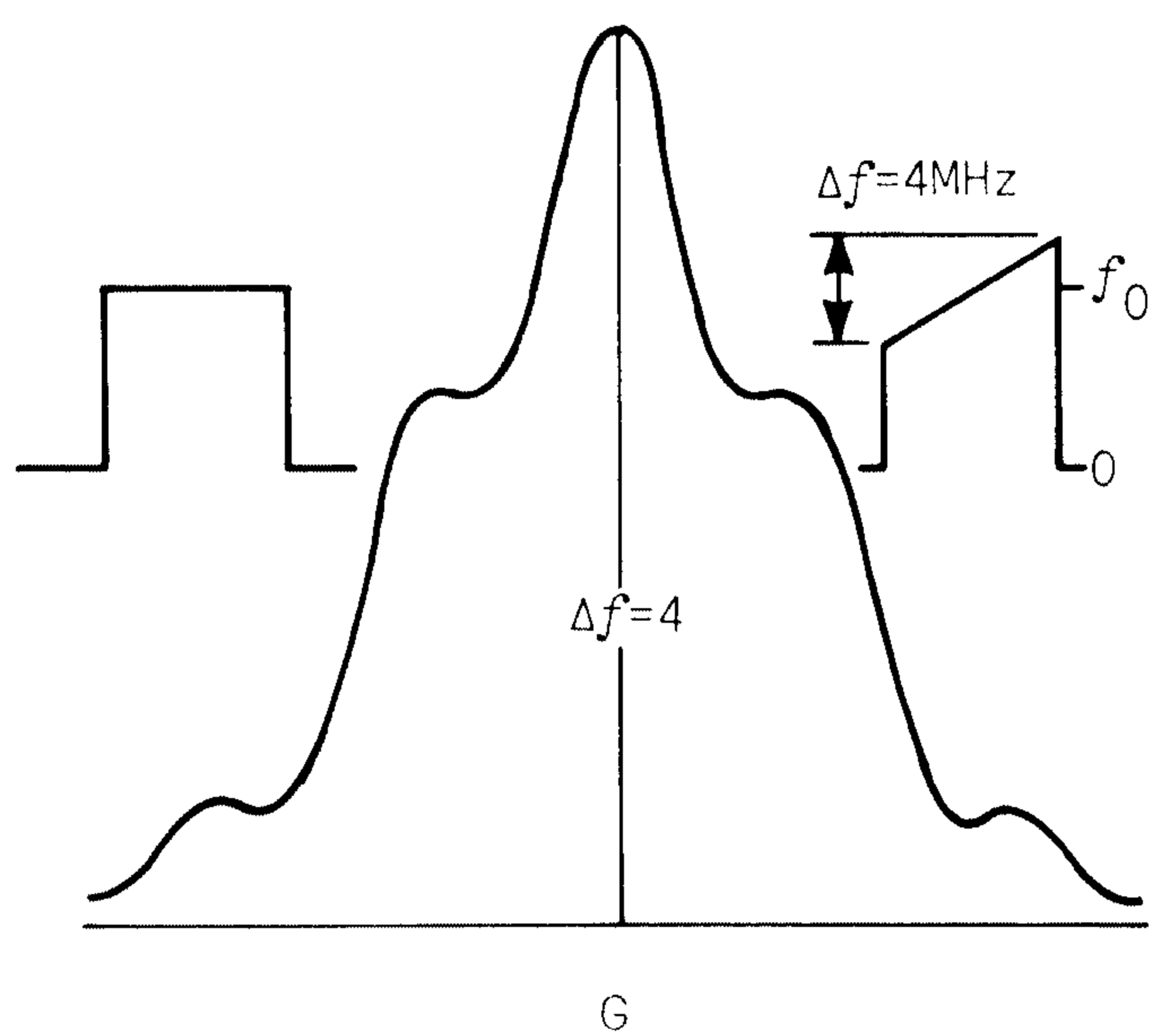
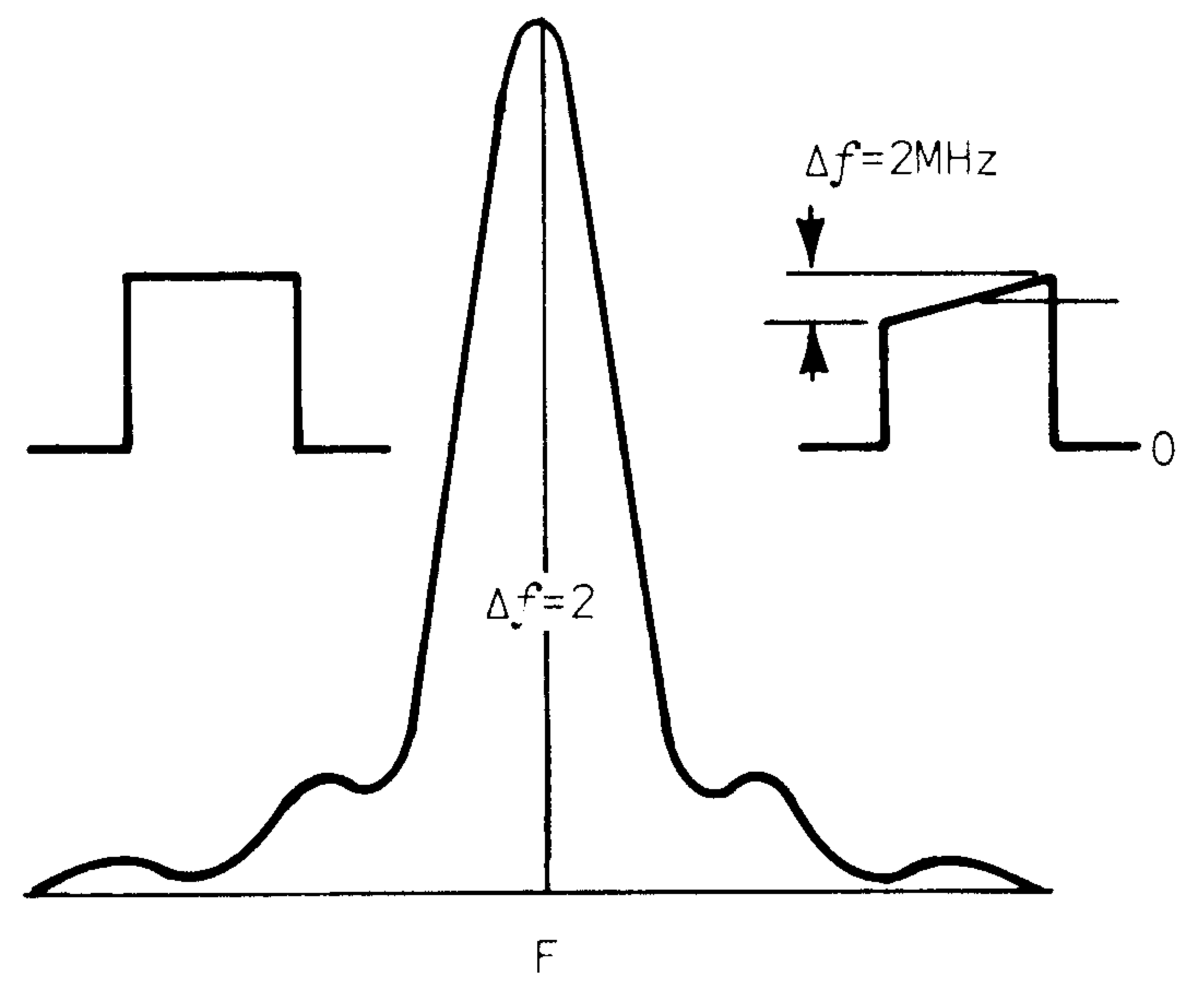
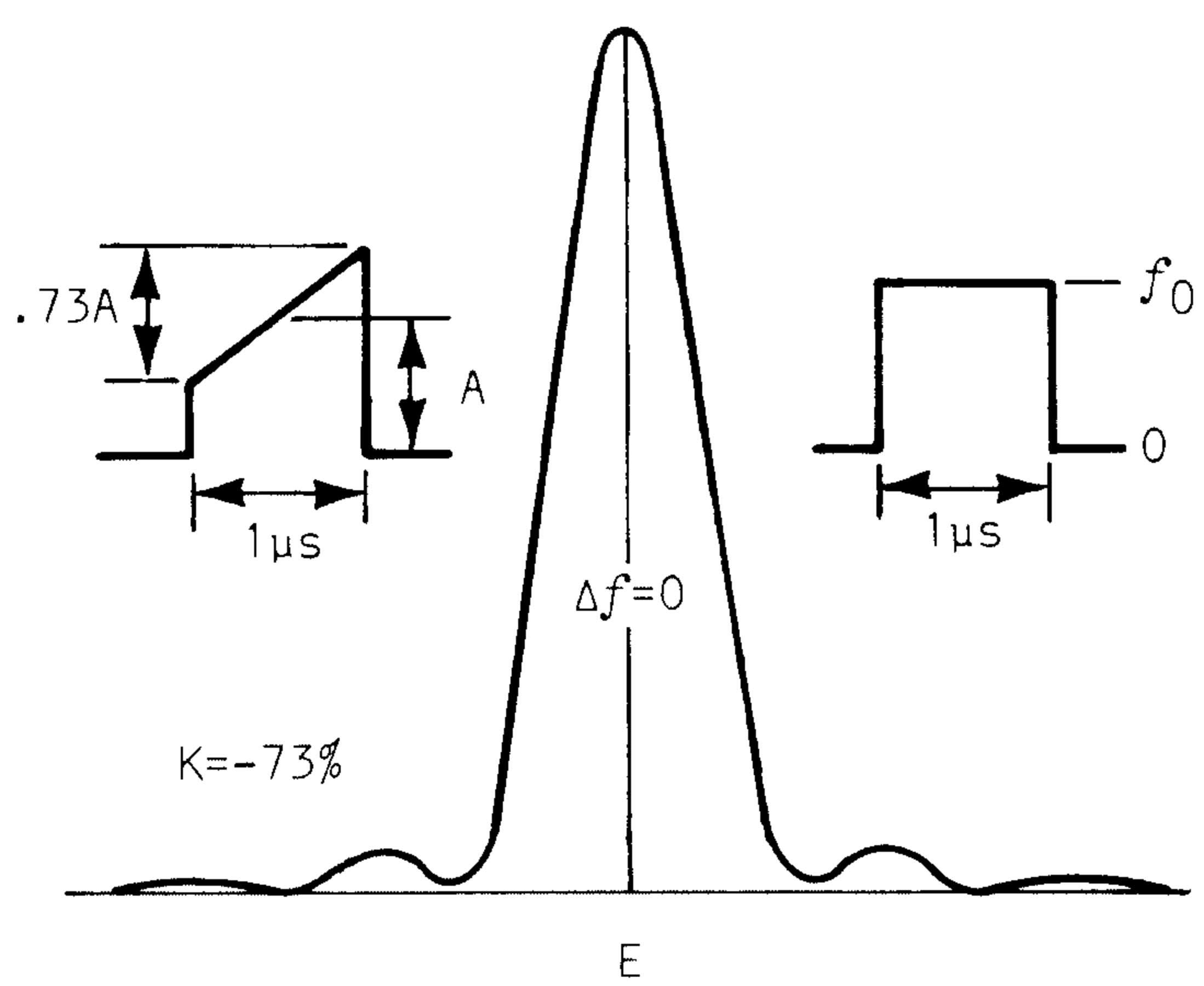
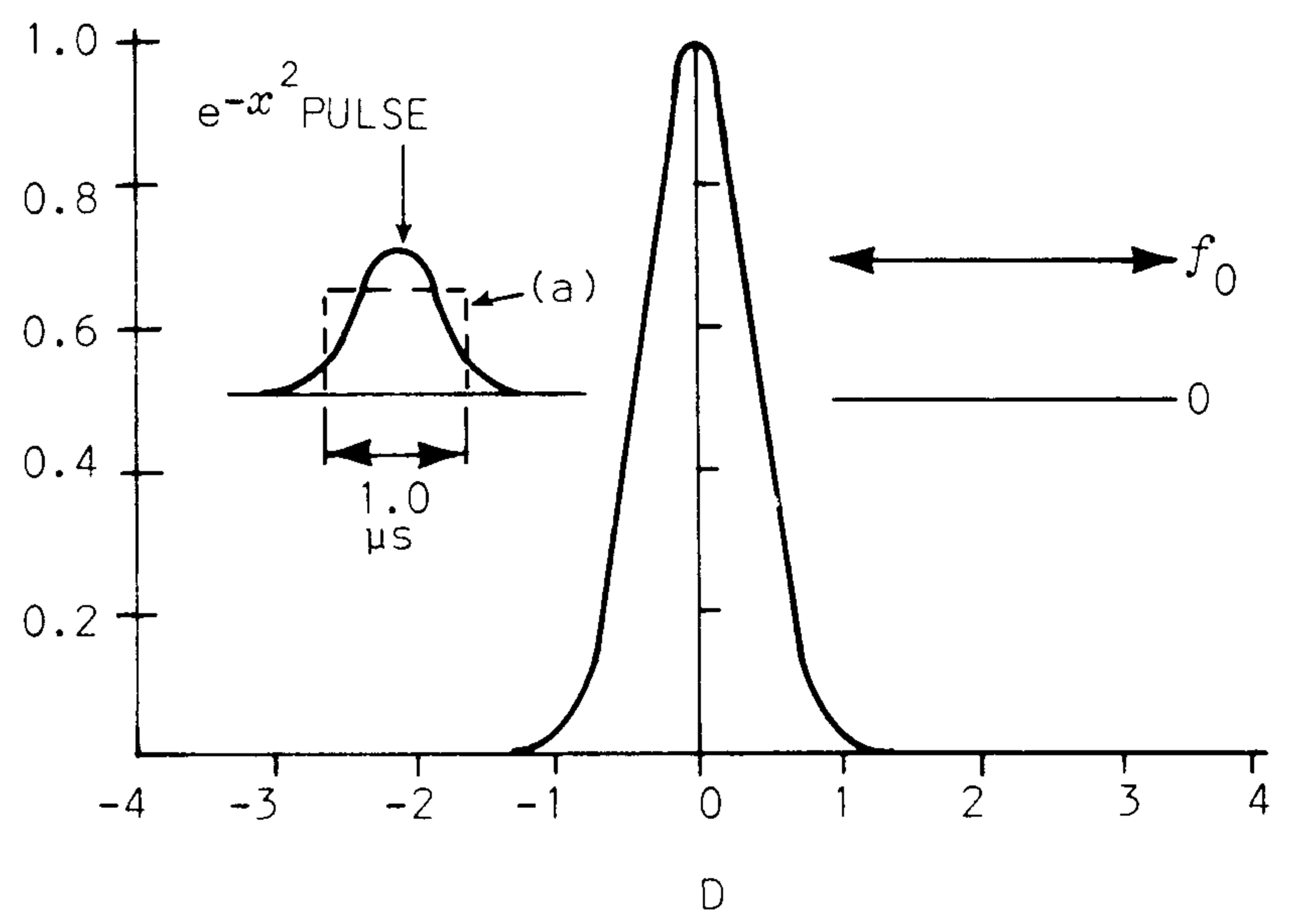
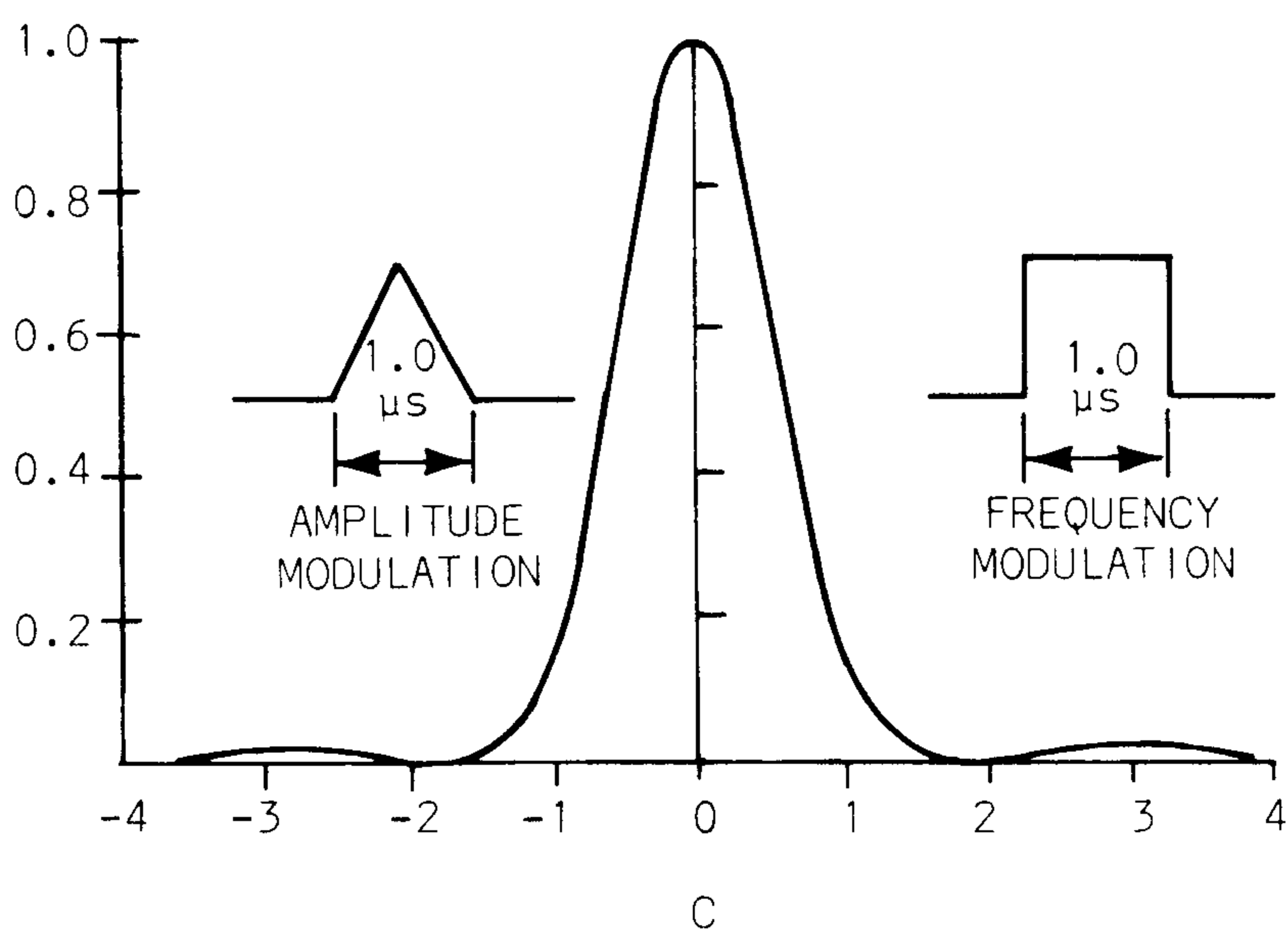
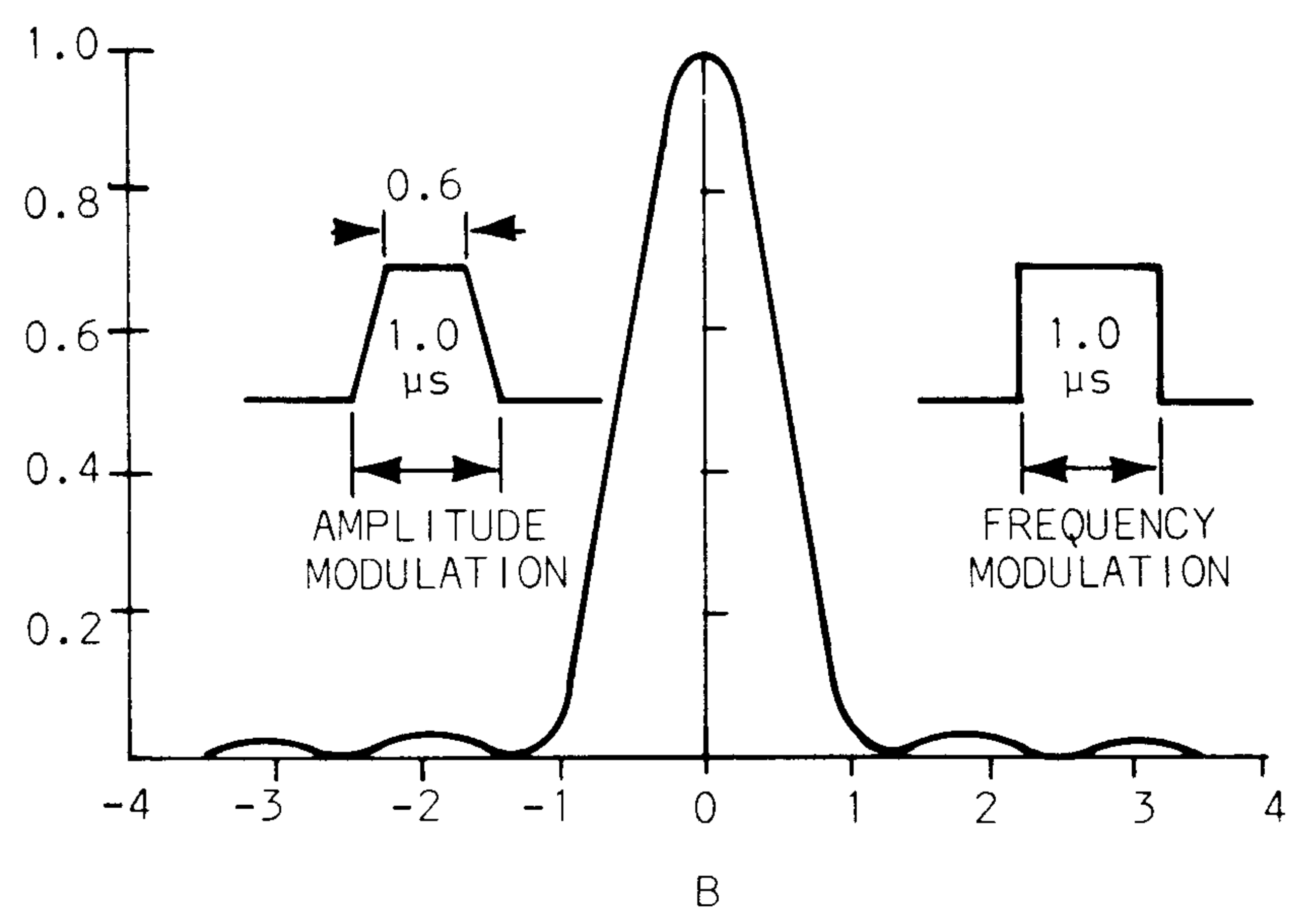
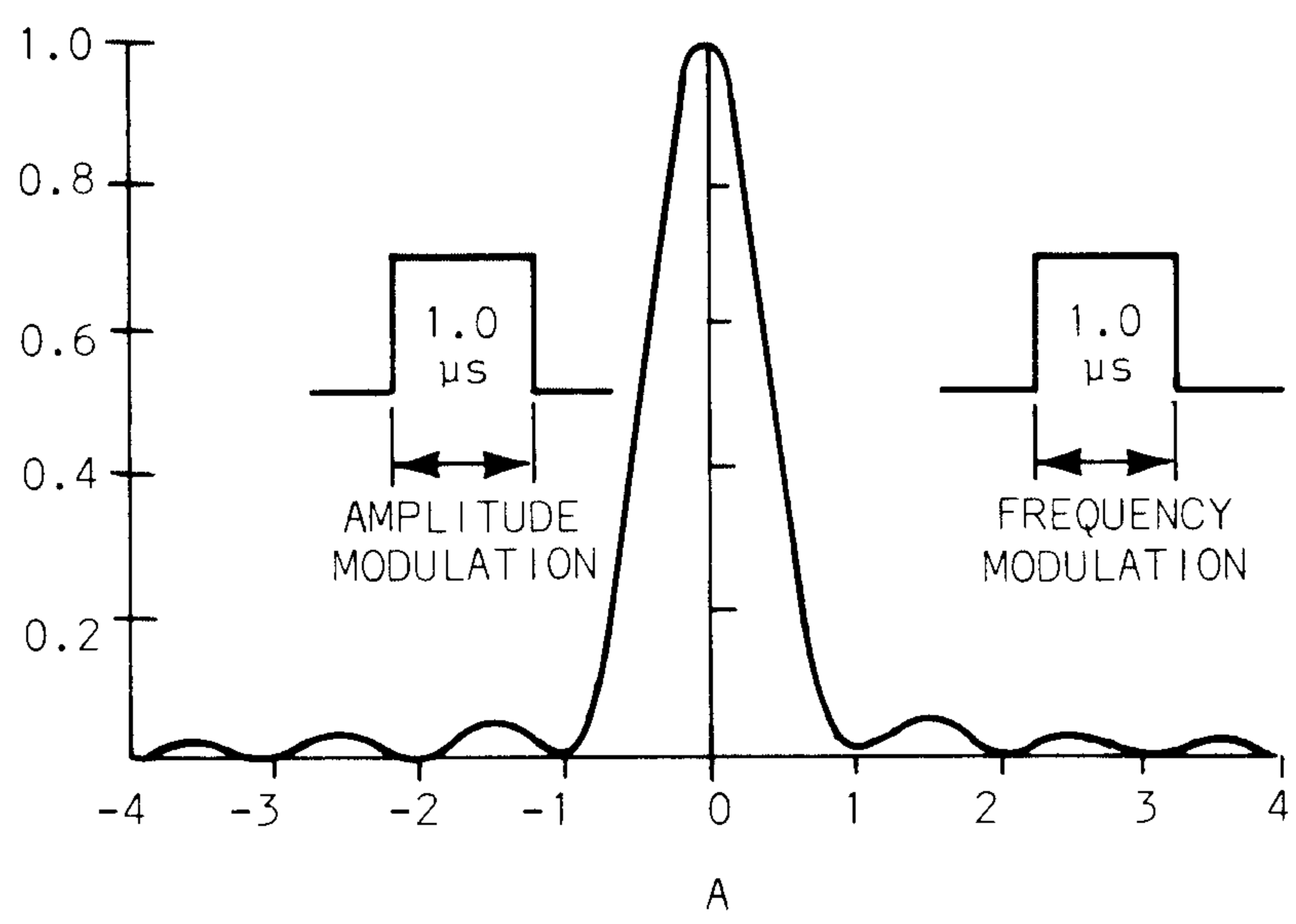


Fig. 10-5. Incidental AM and FM.

## INCIDENTAL AM AND FM

The amount of incidental AM or FM present in a pulsed RF spectrum is generally determined qualitatively by observing the spectrum for major lobe width, minor lobe relative amplitude level, display symmetry and minima or null depth between minor lobes. The display is compared to the series of illustrations shown in Fig. 10-5. The presence of undesired modulation is determined from comparison of the display characteristics. Spreading or asymmetry of the major lobe about the carrier frequency has the effect of reducing the amplitude and fidelity of the detected pulse at the receiver.

## RELATIVE POWER DISTRIBUTION OR SIDE LOBE ATTENUATION MEASUREMENTS

The relative power distribution between the major (main) and minor (side) lobes indicates the fidelity of the transmitted RF pulse. In radar this can be related to the performance of the radar system and therefore is an important characteristic of an RF pulsed spectrum.

In the spectrum of an ideal rectangular pulse, the power level of each of the first set of minor lobes is about 4.5% of that of the major lobe (Fig. 10-6). The energy of each of the second set of side lobes is 1.6% of that of the main lobe. Comparison of the relative amplitude levels of the first set of side lobes to the main lobe should indicate a dB attenuation of approximately 13.5 ( $10 \log \frac{100}{4.5}$ ) for an ideal rectangular RF pulse. The relative amplitude of the first side lobe is usually the only one of any significance.

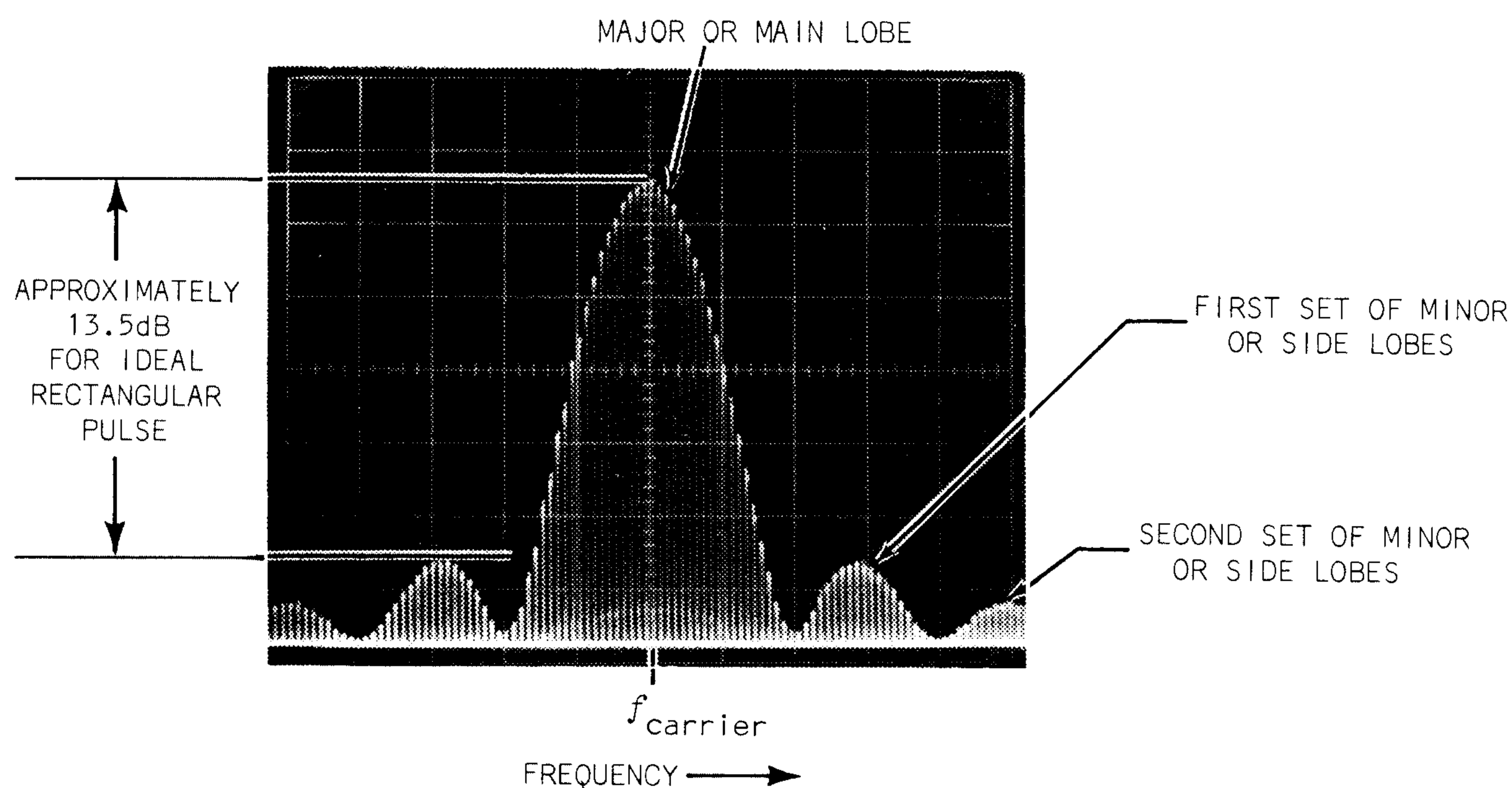
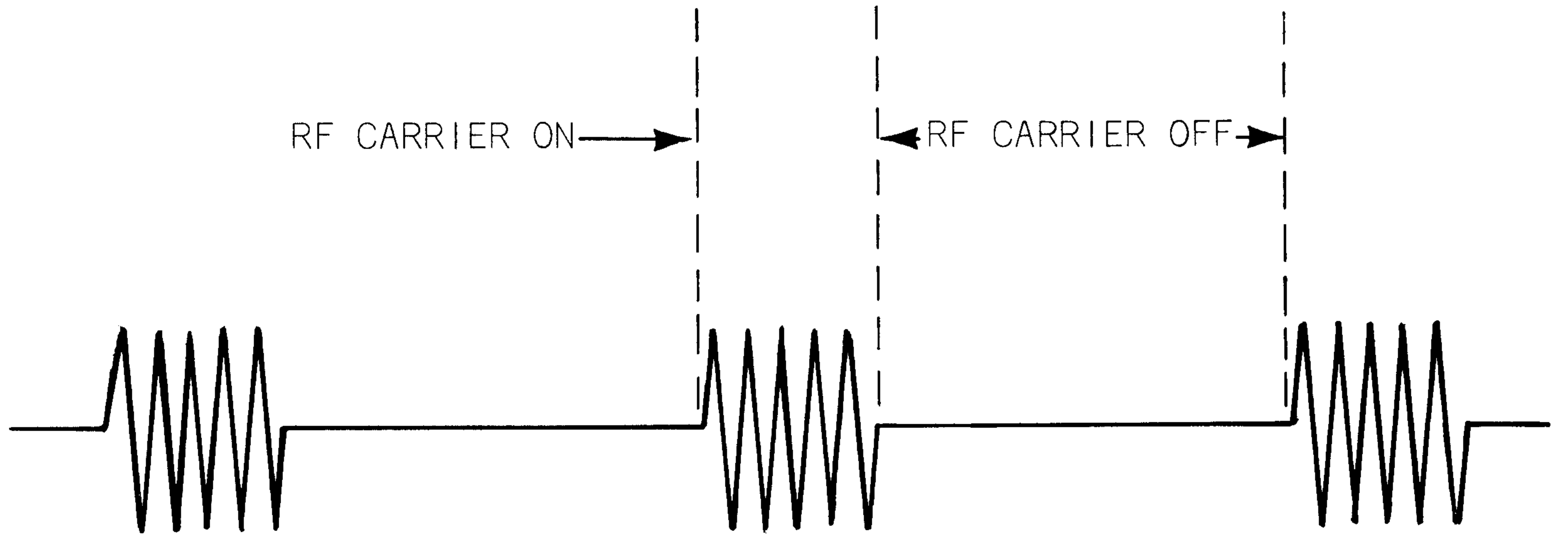
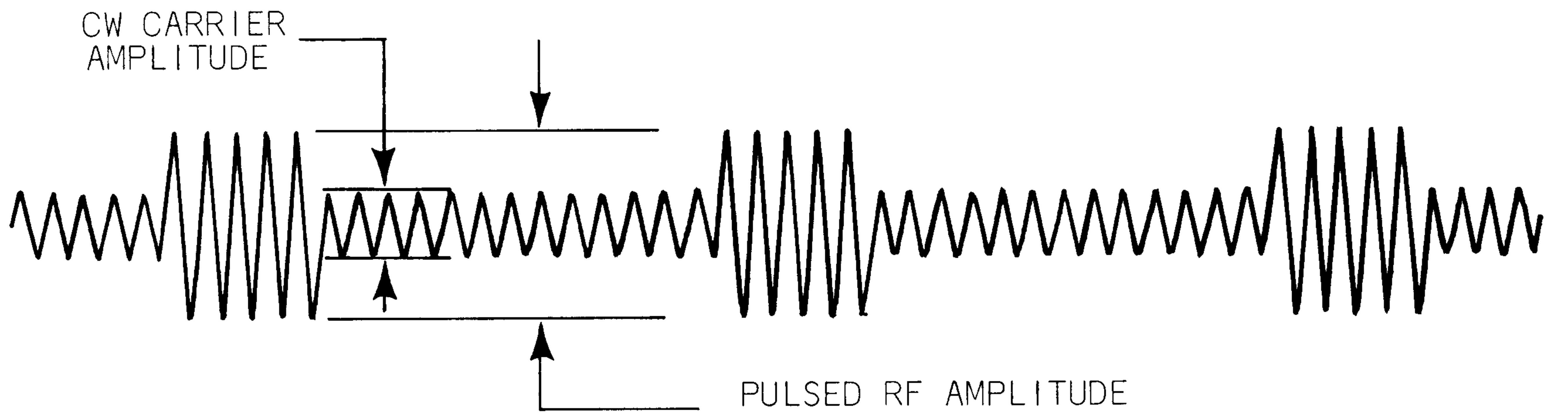


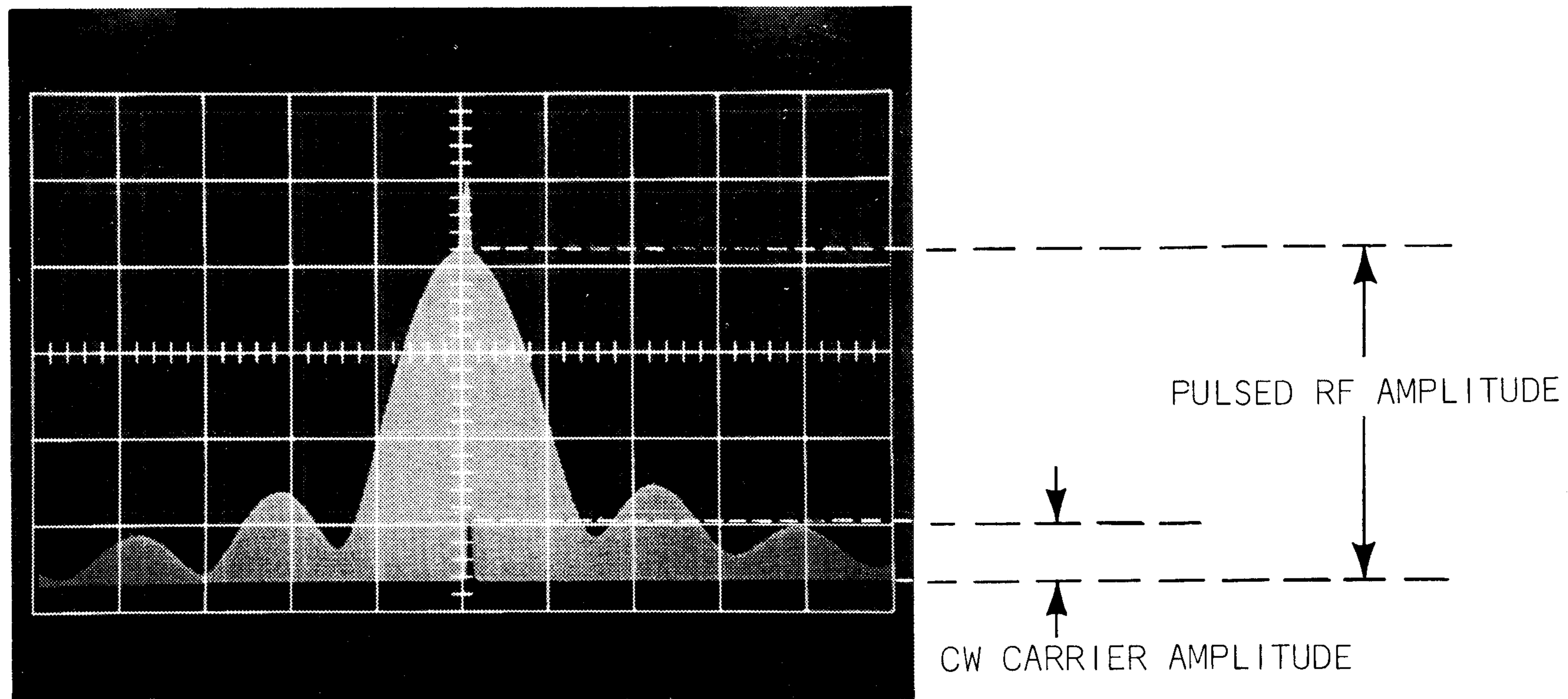
Fig. 10-6. Side lobe attenuation measurement display for a pulsed RF spectrum.



(A) TIME DOMAIN DISPLAY OF IDEAL SIGNAL



(B) TIME DOMAIN DISPLAY OF SIGNAL WITH CW CARRIER PRESENT



(C) FREQUENCY DOMAIN DISPLAY OF SIGNAL WITH CW CARRIER PRESENT

Fig. 10-7. Pulsed RF signal.



The side-lobe attenuation measurement requires that the relative amplitude difference between the main lobe and the first set of side lobes be known. This can be accomplished easily as indicated in Fig. 10-6. The main lobe and first set of side lobes are centered in the display area with the adjustment of the RF center frequency control. The display is adjusted to obtain a convenient reference level for one of the side lobes centered in the middle of the graticule with the main lobe amplitude within the graticule vertical scale limits. With the reference level noted, the IF center frequency coarse control is adjusted to position the main lobe in place of the minor lobe. Front panel attenuation is inserted in the signal display path to decrease the amplitude level of the main lobe to that of the referenced side lobe. Side lobe relative amplitude level can then be read from the front panel switched attenuators.

#### RF PULSE ON-OFF RATIO MEASUREMENTS

In generating a repetitive RF pulse it is desirable that no CW carrier be transmitted between pulses. Presence of CW carrier will distort the spectrum, decrease the efficiency of the transmission system and may result in a degraded signal-to-noise ratio at the receiver output.

RF pulse  
amplitude  
and CW  
carrier

It is sometimes necessary to measure the amount of CW carrier present relative to the RF pulse amplitude. An idealized repetitive RF pulse in the time domain is shown in Fig. 10-7A. The presence of CW carrier for the same signal is shown in Fig. 10-7B. The resulting frequency display is shown in Fig. 10-7C. The spectrum of Fig. 10-7C consists of a combination of a pulsed RF signal and a CW carrier. Direct comparison of the amplitudes of the two signals cannot be made because of the loss in spectrum analyzer display sensitivity to pulsed RF signals. Since the spectrum analyzer sensitivity is a function of the RF pulse duration and spectrum analyzer resolution amplifier bandwidth, the amplitude of the RF pulse signal must be converted to its CW equivalent before a valid comparison measurement can be made.

loss in  
sensitivity

Assuming an RF pulse duration of 1.3 microseconds and a resolution amplifier bandwidth of 100 kHz, the loss in sensitivity can be computed from the equation:

$$\text{Loss in RF pulse sensitivity} = 20 \log \frac{3}{2} t_d \times bw$$

where  $t_d$  = time duration of the RF pulse in seconds

$bw$  = bandwidth of the resolution amplifier  
in Hz.

For the above RF pulse characteristics the loss in sensitivity is approximately 14.2 dB. That is, if the amplitude of the major lobe of the RF pulse spectrum were converted to its CW equivalent amplitude, it would be 14.2 dB greater in amplitude. A comparison measurement between the two signals can now be performed.

RF on/off  
ratio

In performing the measurement, the height of the CW carrier in relation to that of the displayed major lobe spectrum is measured in terms of dB. To this value the number of dB's attributed to the loss in sensitivity is added. The result is a value for the RF carrier on-off ratio. The ratio is the amount of CW carrier feedthrough signal to the amplitude of the RF pulse.\*

In this case the CW signal amplitude is approximately 1/5 of the pulsed signal. This is equivalent to a difference of 14 dB,  $20 \log 5$ . The value of the carrier on-off ratio therefore is 14 dB plus 14.2 dB, equal to 28.2 dB.

---

\* Tektronix Service Scope, Number 41, Dec. 1966, Page 5, Fig. 26, Interpreting Spectrum Analyzer Displays.

## 11

SWEPT FREQUENCY  
MEASUREMENTS

frequency  
response

The frequency response of an amplifier, filter, resonant circuit, etc., can be measured by applying a swept-frequency signal to the input of the device and observing the response on a spectrum analyzer.

In the frequency range of 50 Hz to 1 MHz, the swept-frequency signal may be generated using a Swept Frequency Converter, Tektronix part number 015-0107-00. The converter changes the output frequency of the swept local oscillator into the input center frequency tuning range of the spectrum analyzer. For instance, the 3 to 2-MHz output of the swept local oscillator in the Tektronix Types 1L5 and 3L5 Spectrum Analyzers is applied to the input of the converter where it is heterodyned with a 3-MHz crystal-controlled signal and reconverted to a 0 to 1-MHz (50 Hz to 1 MHz center frequency) swept frequency. The 0 to 1-MHz swept frequency is synchronous with the swept local oscillator. Use of a synchronous swept frequency derived from the spectrum analyzer in this manner imparts the center frequency calibration of the spectrum analyzer to the swept frequency converter. Fig. 11-1 shows a method of measurement applicable to the use of a swept frequency converter in conjunction with a 1L5 or 3L5 spectrum analyzer.

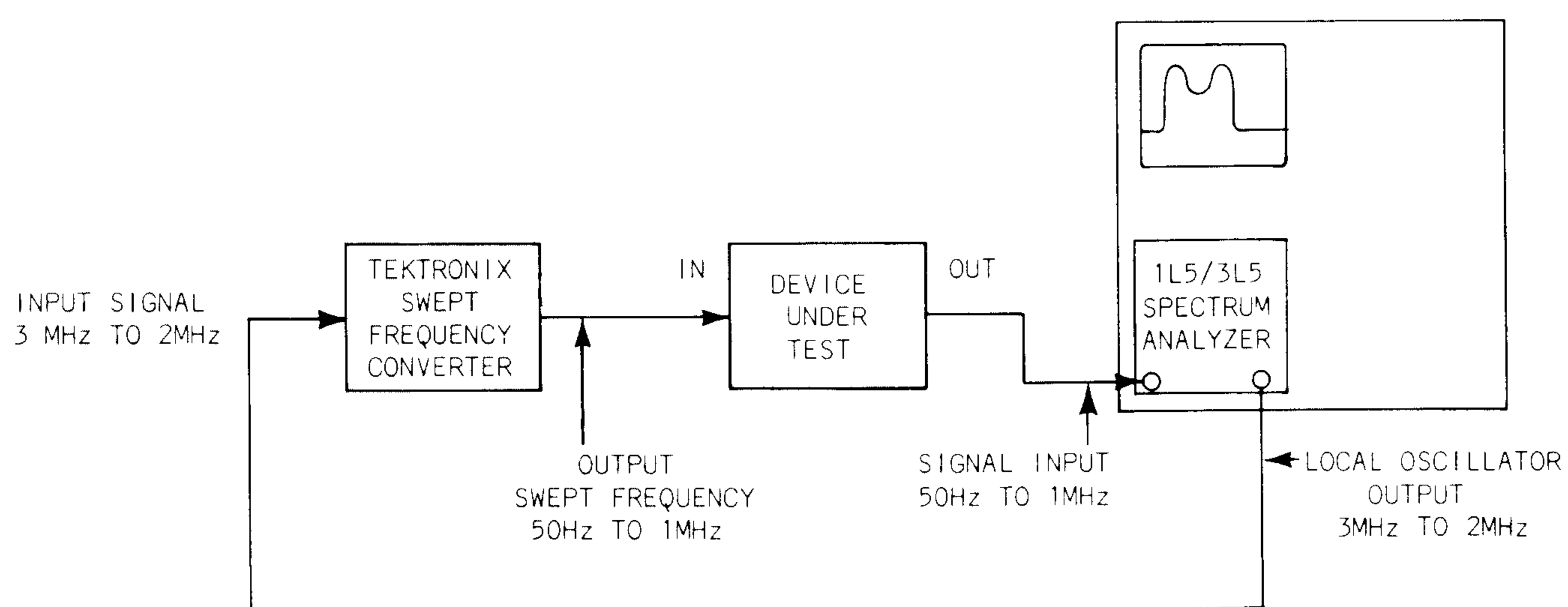


Fig. 11-1. 50-Hz to 1-MHz swept frequency response measurement method using a swept frequency converter.

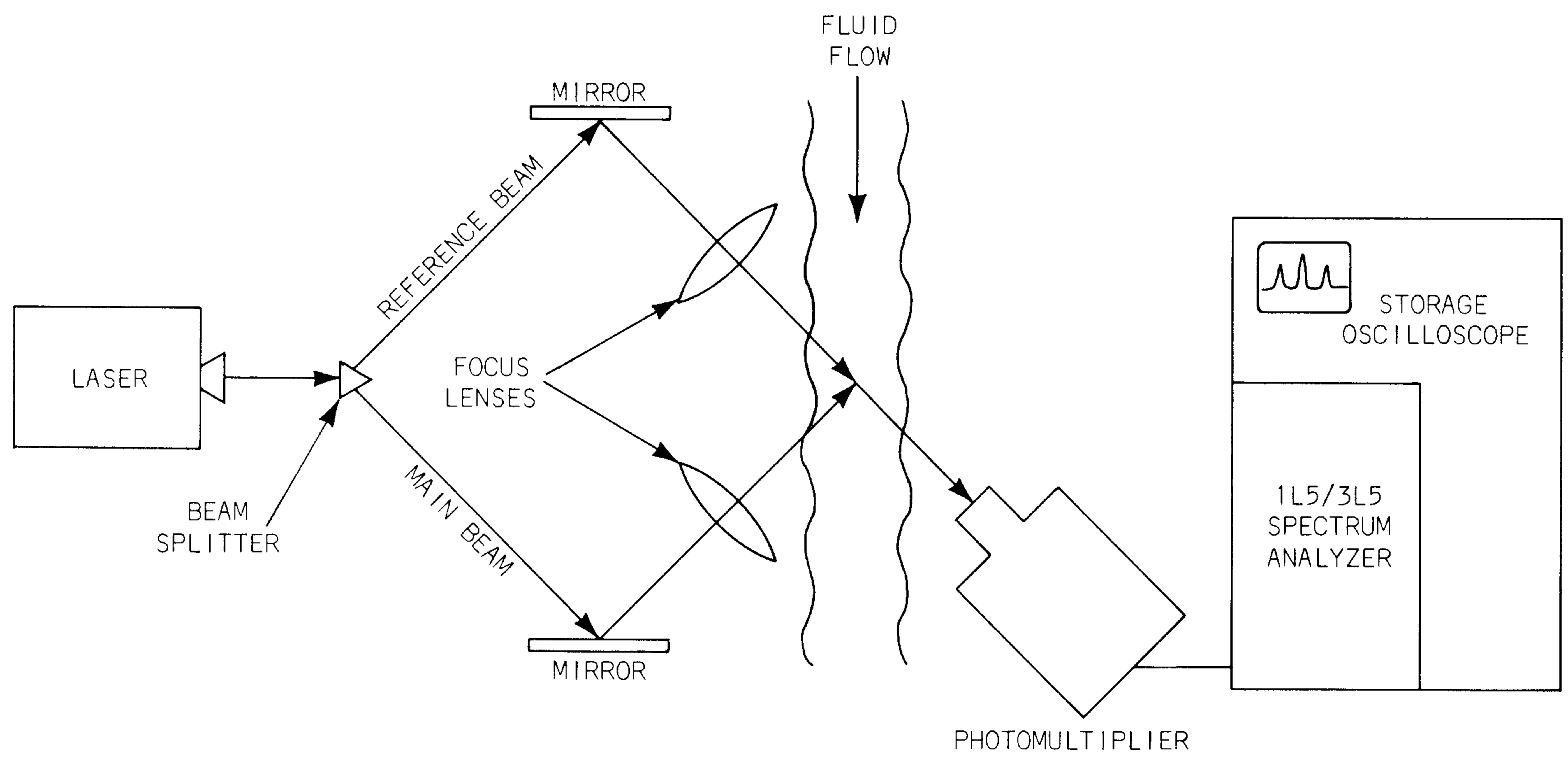


Fig. 12-1. Method of performing fluid velocity measurement.

## 12

FLUID VELOCITY  
MEASUREMENTS

laser  
doppler  
shift

A low frequency spectrum analyzer is useful in fluid velocity measurement application where the spectrum analyzer is used to measure the doppler shift of laser radiation scattered by particles moving with the fluid. From the frequency shift the fluid velocity may be computed to an accuracy approaching a tenth of a percent.

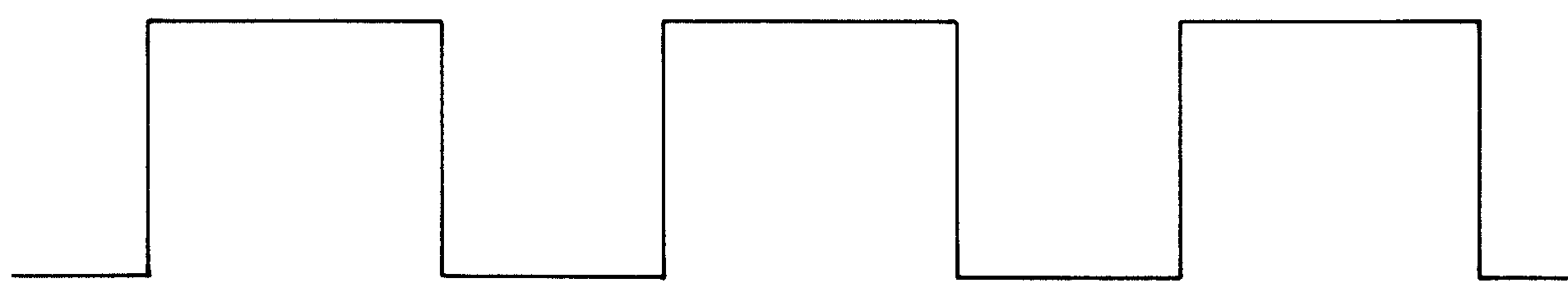
difference  
frequency

The coherent light of a laser beam is split into two beams of equal path length. The beam directions are so arranged that one beam impinges directly onto a photomultiplier tube while the other beam is pointed away from the photomultiplier, as shown in Fig. 12-1. Some of the light from the main beam, which is pointed away from the photomultiplier, is scattered by the moving fluid and enters the photomultiplier along with the light from the other beam. The photomultiplier acts as a mixer, combining the two light beams and producing an electrical signal at the difference frequency. This difference frequency is determined by the velocity of the fluid, which is thus indirectly measurable by the spectrum analyzer.

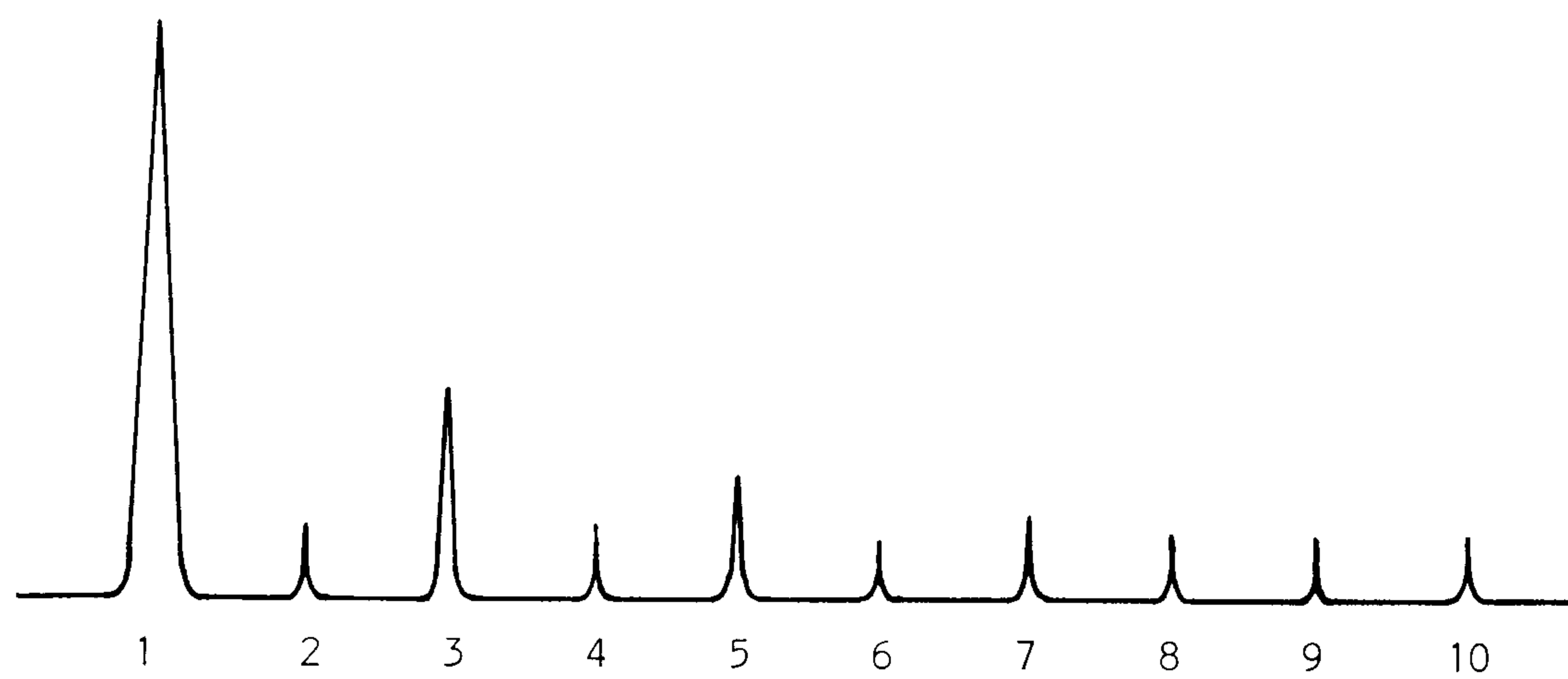
video  
display  
mode

The beat-signal output of the photomultiplier, being low frequency, may be observed on a Tektronix oscilloscope and the video display mode of a low frequency spectrum analyzer during the alignment procedure. Both the Tektronix Types 1L5 and 3L5 Spectrum Analyzers may be used alternately as a 10-Hz to 1-MHz spectrum analyzer or a 10-Hz to 1-MHz AC-coupled vertical amplifier. The sensitivities for both modes of operation are more than adequate for the application. For quantitative measurement the output of the photomultiplier is displayed in the spectrum analyzer mode of operation.





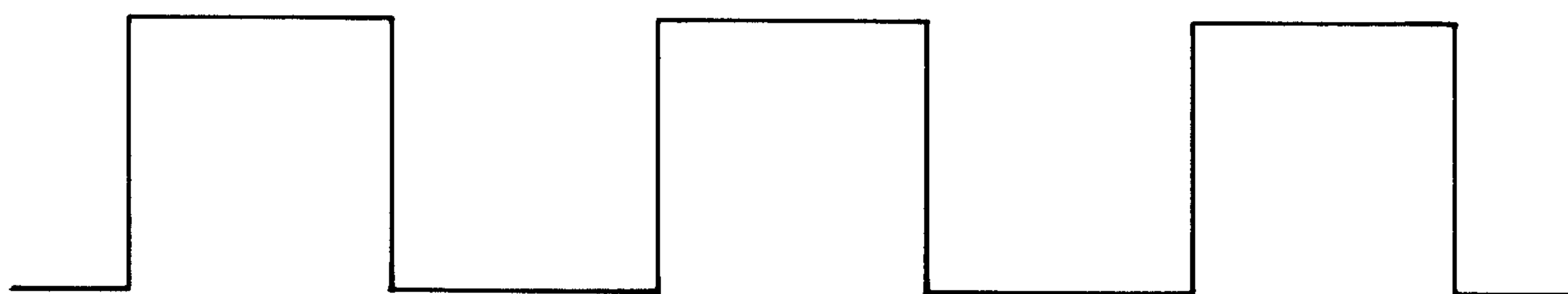
(A) TIME DOMAIN DISPLAY



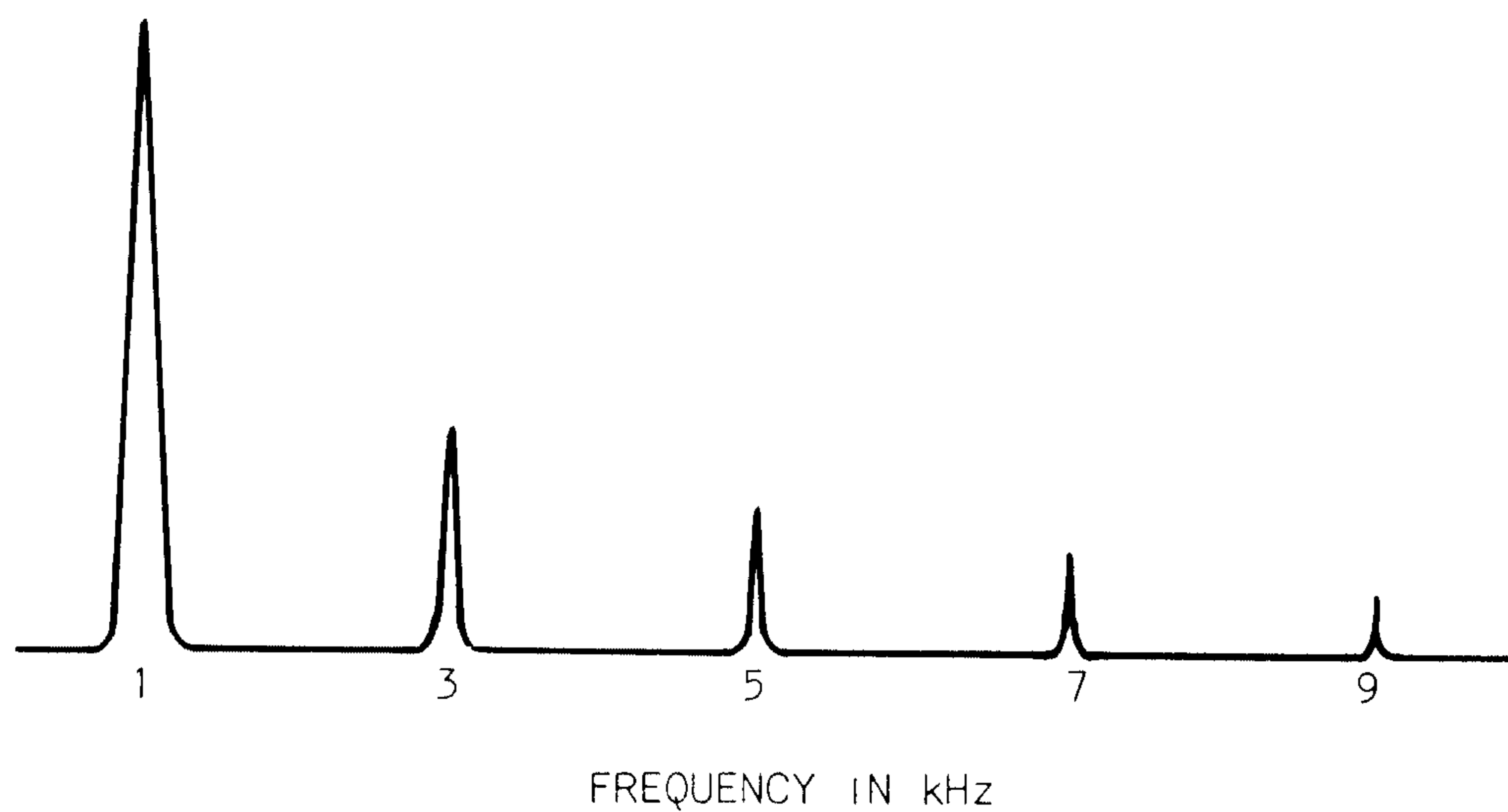
(B) FOURIER-SERIES FREQUENCY COMPONENTS

Fig. 13-1. 1-kHz unsymmetrical squarewave.

ON TIME = OFF TIME



(A) TIME DOMAIN DISPLAY



(B) FOURIER-SERIES FREQUENCY COMPONENTS

Fig. 13-2. 1-kHz symmetrical squarewave.

## 13

## WAVEFORM ANALYSIS

components

Fourier Series

The ability to display input signals in both the time and frequency domain can be valuable in circuit design. There are many waveforms whose characteristics can be more easily identified in terms of components in the frequency spectrum than as waveform changes with respect to time. As an example Fig. 13-1A shows a 1-kHz squarewave from a pulse generator. Careful examination of the output pulse reveals that the duty cycle for the on and off periods are not equal. Fig. 13-1B shows the same 1-kHz squarewave in the frequency domain. The presence of even-order Fourier series frequency components immediately reveals that the waveform is not a true squarewave.

a true squarewave

By comparison, Fig. 13-2A shows a time display of a true 1-kHz squarewave and Fig. 13-2B shows the Fourier series frequency components present in this waveform. It is immediately obvious that a true squarewave (equal on and off durations) contains no even-order Fourier components.

frequency spectrum

In the analysis of complex waveforms, e.g., vibrational, accoustical, biological, speech analysis; the frequency spectrum can often be more revealing because of the differentiation in the individual frequency components and their relative amplitudes.

Singular waveform events may be recorded on magnetic tape and made continuous or repetitive by playback of the recording on an endless loop of tape. In this manner a pulsed-frequency spectrum of the event is generated and it may be analyzed in terms of its Fourier components.

## INDEX

- Amplitude modulation, 9-14, 36, 65-70  
 Double sideband suppressed carrier, 9, 12-13  
 Single sideband suppressed carrier, 9, 13-14  
 Pulse modulated carrier, 9, 14-19, 37-39
- Amplitude modulation measurements, 65-70
- Anomalous IF responses, *see* Spurious responses
- Cavity resonator Q measurements, 62-64
- Carrier suppression measurements, 81
- Center frequency (defined), 23
- Center frequency determination, 47-50
- Center frequency range (defined), 23
- Continuous wave (CW) signal, 9, 36  
 measurements of, 47-64
- Deviation measurements, 71-79
- Deviation ratio, 21
- Dial scales, 41, 43-44
- Dispersion (defined), 23  
 as related to resolution, 34-36
- Dispersion control, 44
- Dispersion linearity, *see* Linearity
- Display flatness (defined), 23
- Doppler shift, 99
- Drift (defined), 23
- Dynamic range (defined), 24
- Fluid velocity measurements, 99
- Frequency band (defined), 24
- Frequency conversion, 59-61
- Frequency division multiplex, 68-70
- Frequency modulation, 19-22, 36, 71-79
- Frequency modulation measurements, 71-79  
 deviation, 71-77  
 deviation linearity, 78-79
- Frequency sampling, 3
- Frequency scale (defined), 24
- Frequency stability measurements, 50-52
- Frequency sweeping, *see* Sweep tuning
- Frequency synthesizer (defined), 24
- Harmonic conversion, *see* Spurious responses
- Harmonic measurements, 56-57
- IF center frequency control, 43-44
- Incidental frequency modulation (defined), 24
- Incremental linearity (defined), 25
- Intensifier control, 43
- Intermediate frequency, *see* Center frequency
- Intermediate frequency feedthrough, *see* Spurious responses
- Intermodulation, *see* Spurious responses
- Intermodulation distortion measurements, 82-86
- Image response, *see* Spurious responses
- Laser doppler shift, 99
- Linear display (defined), 25
- Linearity (defined), 25
- Local oscillator radiation (defined), 25
- Logarithmic display (defined), 31
- Maximum input power (defined), 25
- Minimum discernible signal, *see* Sensitivity
- Minimum usable dispersion (defined), 25
- Mixer conversion, 59-61
- Modulation frequency measurements, 68-70
- Modulation index, 20, 74-76
- Multiplex measurements, 68-70
- Multipulse, 22

- Optimum resolution (defined), 26
- Optimum resolution bandwidth (defined), 26
- Phase lock (defined), 25
- Phase modulation, 20
- Picket fence (defined), 25
- Pulse duration measurements, 89-90
- Pulse modulation, 9, 14-19, 37-39, 87-96
- Pulse modulation measurements, 87-96
- Pulse on-off ratio measurements, 95-96
- Pulse repetition frequency measurements, 90-91
- Q measurements, 62-64
- Radiation measurements, 61
- Radio frequency, *see* Center frequency
- Residual frequency modulation, *see* Incidental frequency modulation
- Resolution (defined), 26-28  
factors affecting, 33-39, 44-46
- Resolution bandwidth, *see* Resolution
- Resolution bandwidth control, 39, 42, 46
- RF carrier, 9-22
- Safe power level (defined), 28
- Scanning, *see* Sweep tuning
- Scanning velocity (defined), 28
- Sensitivity, 28
- Sidebands, 9-14, 20-21, 82
- Sideband suppression measurements, 82
- Side lobe attenuation measurements, 93-95
- Signal-to-distortion ratio measurements, 82-86
- Skirt selectivity (defined), 29
- Spectral purity, 53
- Spur, *see* Spurious responses
- Spurii, *see* Spurious responses
- Spurious responses (defined), 30-31
- Squegging, 56
- Square law display (defined), 31
- Stability, *see* Drift
- Sweep repetition rate (defined), 31
- Sweeptime (defined), 31  
as related to resolution, 34-36
- Sweep tuning, 4
- Sweep width, *see* Dispersion
- Swept frequency measurements, 97
- Swept front end, 4-5, 29
- Swept IF, 4, 6-7, 29
- Triggering, 42-43
- Video detection, *see* Spurious responses
- Video display (defined), 32
- Video filter, 42
- Zero frequency feedthrough (defined), 32
- Zero pip, *see* Zero frequency feedthrough

BOOKS IN THIS SERIES:

*Circuit Concepts*

Power Supply Circuits

062-0888-01

Oscilloscope Cathode-Ray Tubes

062-0852-01

Storage Cathode-Ray Tubes and Circuits

062-0861-01

Television Waveform Processing Circuits

062-0955-00

Digital Concepts

062-1030-00

Spectrum Analyzer Circuits

062-1055-00

Oscilloscope Trigger Circuits

062-1056-00

Sweep Generator Circuits

062-1098-00

*Measurement Concepts*

Information Display Concepts

062-1005-00

Semiconductor Devices

062-1009-00

Television System Measurements

062-1064-00

Spectrum Analyzer Measurements

062-1070-00

Engine Analysis

062-1074-00

Automated Testing Systems

062-1106-00

Probe Measurements

062-1170-00